

フラット型ハイパワー用ヒートシンク F series

放熱設計のポイント

熱の移動形態には3種類あります (表1)。 表1 熱の移動形態

移動形態	用語説明	具体例	ヒートシンクでのパラメータ
熱伝導	物質内を熱だけが移動する形態	アルミ材の端を温めるとアルミ全体に伝わっていく。	材質、熱輸送距離、熱輸送断面
熱伝達	物質とともに熱が移動する形態	扇風機を使うと体温により温められた体周辺の空気が移動して、室内の温められてない空気と交換されるため、涼しく感じる。	フィンピッチ、フィン表面積
放射	電磁波により熱を移動する形態	太陽により地面が温められる。	環境温度

その3種類の移動形態+コストを考慮して、最適なヒートシンク的设计・選択を行います。ヒートシンクを设计・選択する際に表2が重要なポイントとなります。

表2 ヒートシンク设计・選択時ポイント

条件	設計時注目すべき熱の移動形態			コメント
	熱伝導	熱伝達	放射※	
自然空冷		○		有効な表面積が稼げるかがポイント。そのため、「性能が良い=ヒートシンクが巨大」となりやすい。
強制空冷	○			フィンへ効率よく熱が伝えられるかが勝負である。場合によってはヒートパイプ等の高熱伝導デバイスを用いることもある。
全面加熱		○		フィン設計が重要なポイントとなる。加熱部が中央配置の場合、ヒートシンクベース面積の50%以上が受熱面積であれば、全面加熱に近い。
集中加熱	○			ヒートシンクを大きくしても性能が上がらず、逆に悪くなることもある。性能をあげるためにはベース面全体へどう熱を伝えるかが重要となる。加熱部が中央配置の場合、ヒートシンクベース面積の30%以下が受熱面積であれば、集中加熱に近い。

※放射は環境条件によりかなり左右されるため、当社としましては+α要因として設計時には考慮致しません。

素材押出し公差 (JIS H4100 : 2022 より抜粋) 単位 mm

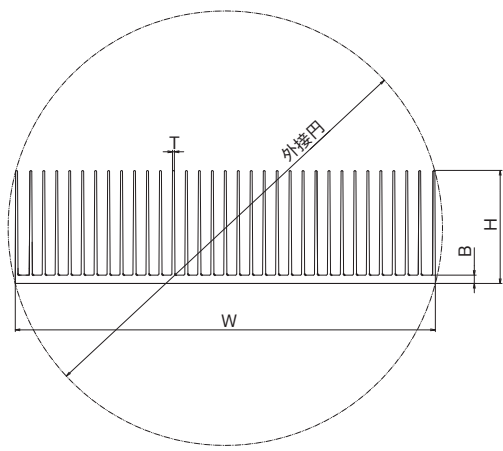

平らさの許容差⁽²²⁾ ⁽²⁴⁾

単位 mm

幅 W	許容差							
	普通級				特殊級			
	中実形材		中空形材		中実形材		中空形材	
	測定箇所の最小肉厚 t							
	—		—		5.0 以下		5.0 を超えるもの	
	任意箇所の幅 25 につき	全幅 W につき	任意箇所の幅 25 につき	全幅 W につき	任意箇所の幅 25 につき	全幅 W につき	任意箇所の幅 25 につき	全幅 W につき
25 以下	—	0.20 以下	—	0.10 以下	—	0.15 以下	—	0.10 以下
25 を超え	0.20 以下	0.008W 以下	0.10 以下	0.004W 以下	0.15 以下	0.006W 以下	0.10 以下	0.004W 以下

ねじれの許容差 (最大値)

単位 mm

外接円の直径※)	ねじれ [幅 (W) 1mm につき]			
	合金グループ 1		合金グループ 2	
	長さ 1m につき	全長 l につき	長さ 1m につき	全長 l につき
12.5 を超え 40 以下	0.052 以下	0.122 以下	0.070 以下	0.140 以下
40 を超え 80 以下	0.026 以下	0.087 以下	0.034 以下	0.105 以下
80 を超え 250 以下	0.017 以下	0.052 以下	0.026 以下	0.070 以下
250 を超え 800 以下	0.010 以下	0.040 以下	0.017 以下	0.058 以下

寸法公差表

外接円	指定箇所の寸法		H・B・W・T (普通級)	H・B・W・T (特殊級)
	250 以下	3.2 超え	3.2 以下	±0.23
6.3 超え		6.3 以下	±0.27	±0.18
12.5 超え		12.5 以下	±0.30	±0.20
20 超え		20 以下	±0.35	±0.23
25 超え		25 以下	±0.38	±0.25
40 超え		40 以下	±0.45	±0.30
50 超え		50 以下	±0.54	±0.36
100 超え		100 以下	±0.92	±0.60
150 超え		150 以下	±1.30	±0.86
200 超え		200 以下	±1.70	±1.10
250 超え		250 以下	±2.10	±1.35
250 を超え		3.2 超え	3.2 以下	±0.54
	6.3 超え	6.3 以下	±0.57	±0.38
	12.5 超え	12.5 以下	±0.62	±0.41
	20 超え	20 以下	±0.65	±0.43
	25 超え	25 以下	±0.69	±0.46
	40 超え	40 以下	±0.72	±0.48
	50 超え	50 以下	±0.92	±0.60
	100 超え	100 以下	±1.30	±0.86
	150 超え	150 以下	±1.70	±1.10
	200 超え	200 以下	±2.10	±1.35
	250 超え	250 以下	±2.40	±1.65
	300 超え	300 以下	±2.80	±1.90
	350 超え	350 以下	±3.20	±2.15
	400 超え	400 以下	±3.60	±2.40
	450 超え	450 以下	±4.00	±2.65
500 超え	500 以下	±4.70	±3.15	
550 超え	600 以下	±5.10	±3.40	

曲がりの許容差⁽²²⁾ ⁽²³⁾

単位 mm

外接円の直径※)	最小肉厚	許容差			
		普通級		特殊級	
38 以下	2.4 以下	2 以下	6.6 × $\frac{h}{1000}$ 以下	1.3 以下	4.3 × $\frac{h}{1000}$ 以下
	2.4 を超えるもの	0.6 以下	2 × $\frac{h}{1000}$ 以下	0.3 以下	1 × $\frac{h}{1000}$ 以下
38 を超え 300 以下	—	—	—	—	—
300 を超え	—	0.6 以下	2 × $\frac{h}{1000}$ 以下	0.5 以下	1.6 × $\frac{h}{1000}$ 以下

注※) 表9の注※) による

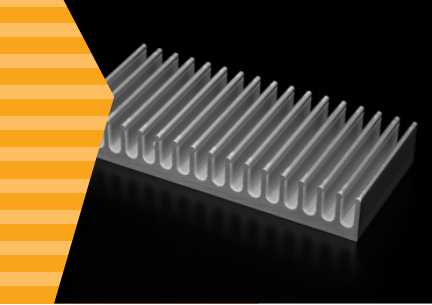

F series フラット型ハイパワー用ヒートシンク

12F 31 .

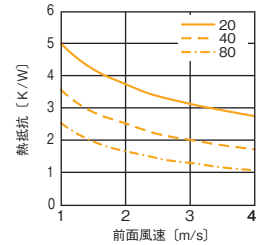
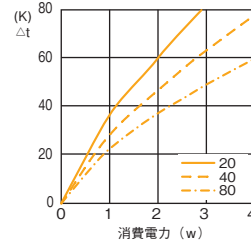
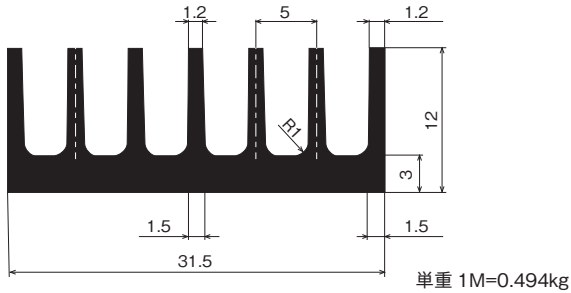

12F 46 .

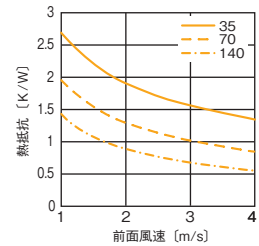
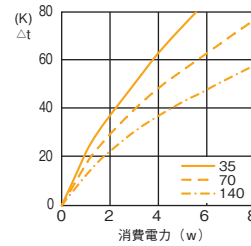
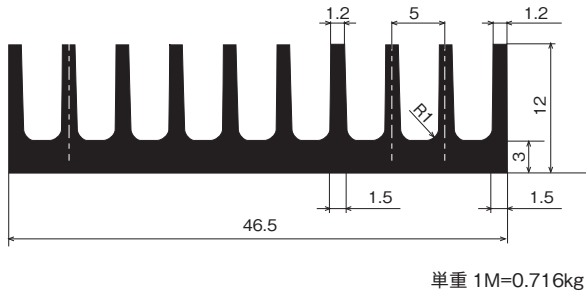

12F 51 .

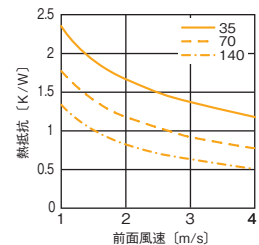
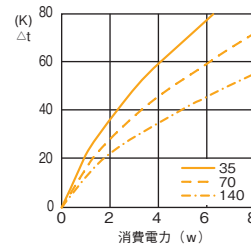
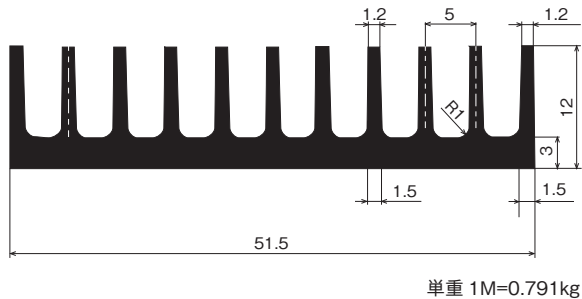

12F 66 .

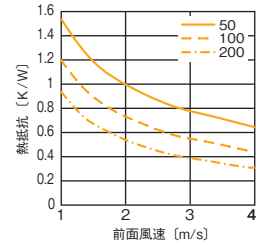
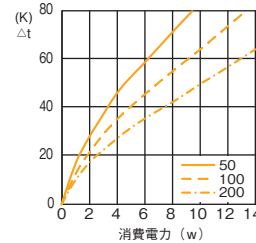
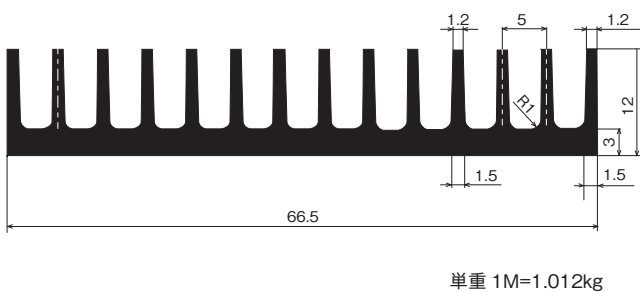

12F 101 .

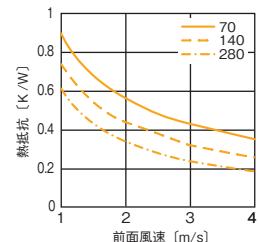
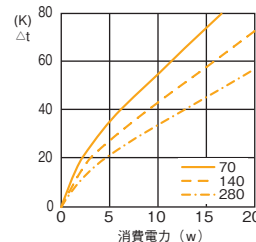
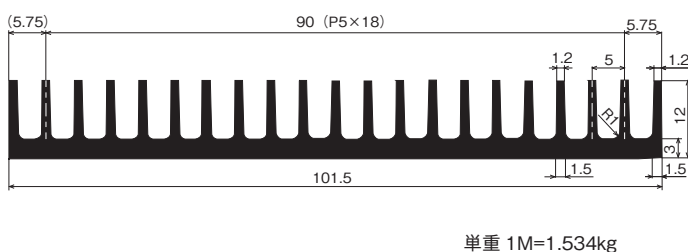

フラット型ハイパワー用ヒートシンク F series

12F 151

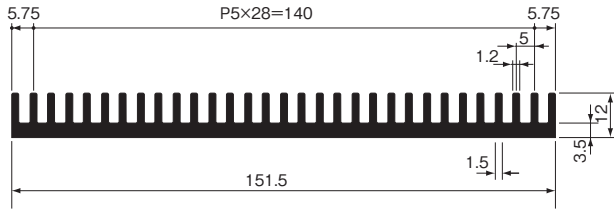

単重 1M=2.427kg

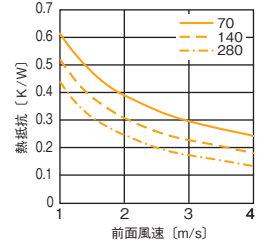
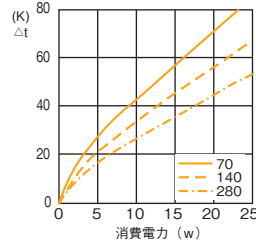

12F 196

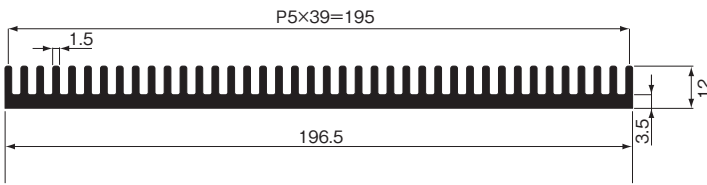

単重 1M=3.116kg

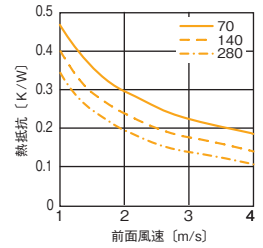
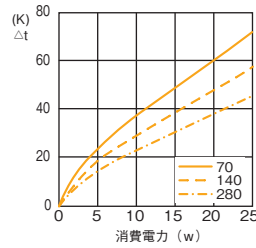

12F 301

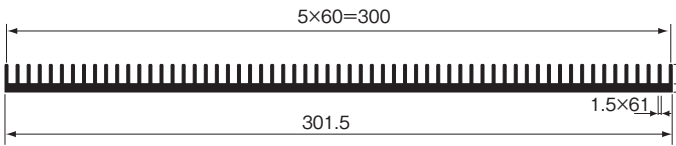

単重 1M=4.768kg

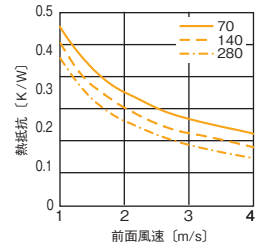
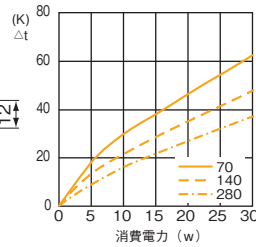

17F 44

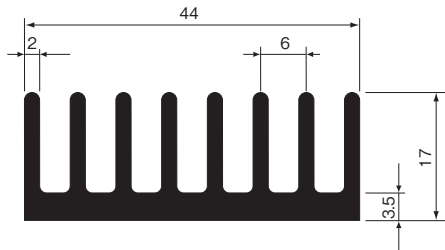

単重 1M=0.998kg

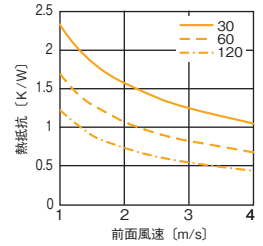
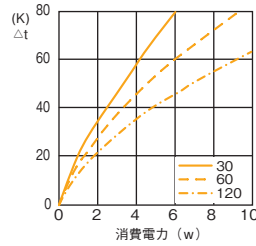

17F 50

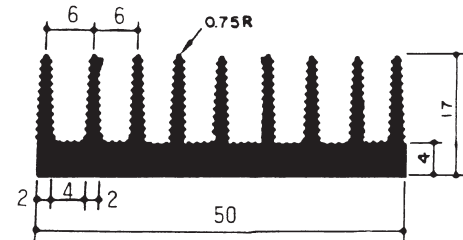

単重 1M=1.002kg

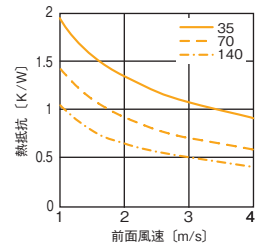
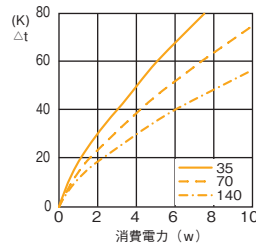

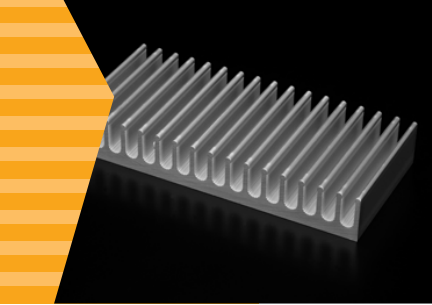

F series フラット型ハイパワー用ヒートシンク

17F S50

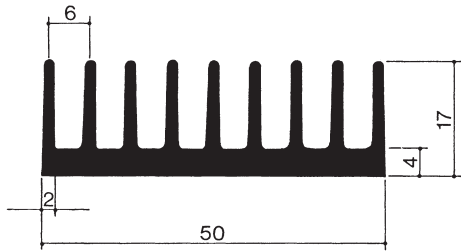

単重 1M=1.083kg

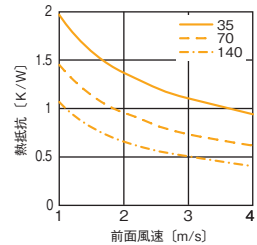
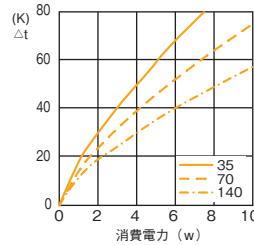

17F 98

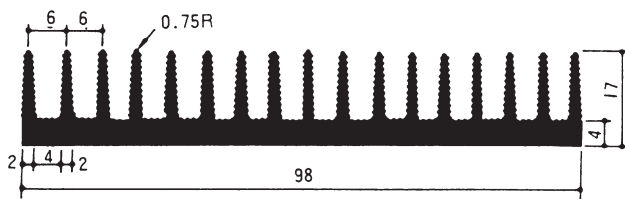

単重 1M=1.927kg

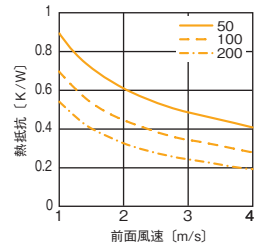
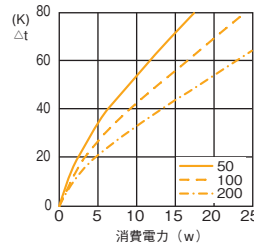

17F 146

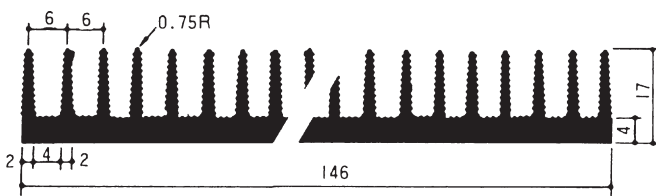

単重 1M=2.87kg

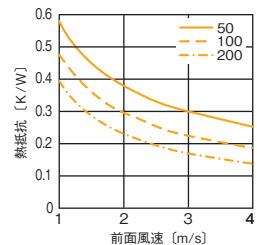
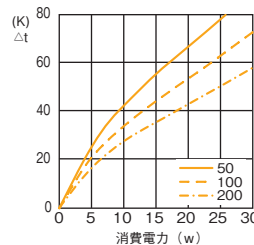

17F 200

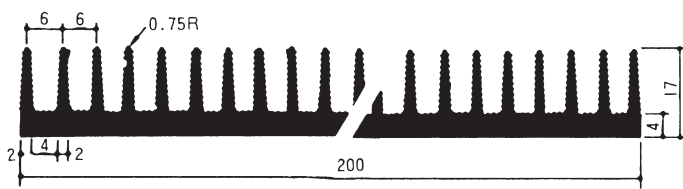

単重 1M=3.9kg

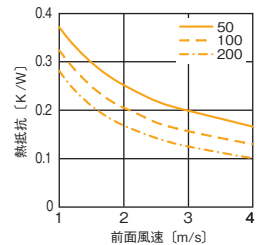
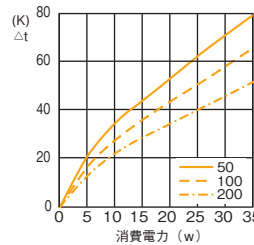

17F 302

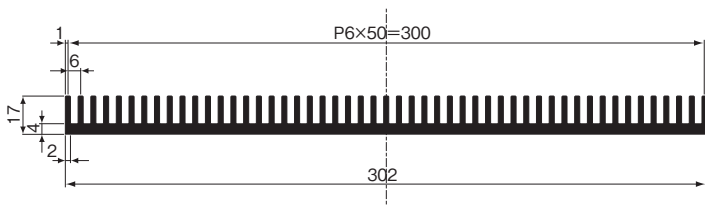

単重 1M=6.419kg

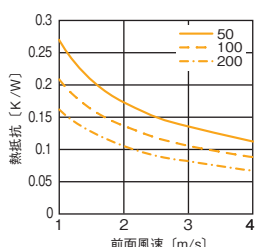
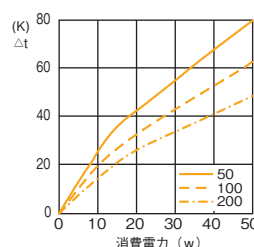

フラット型ハイパワー用ヒートシンク F series

20F 25 .

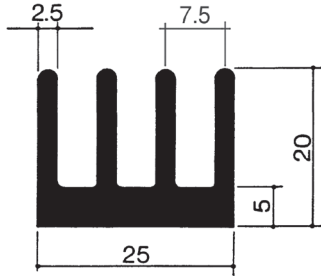

単重 1M=0.738kg

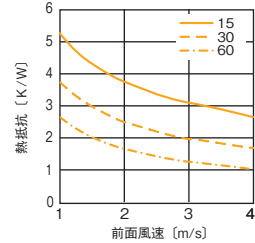
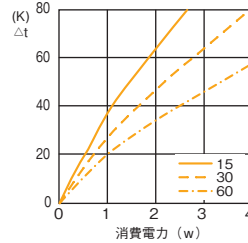

20F 48 .

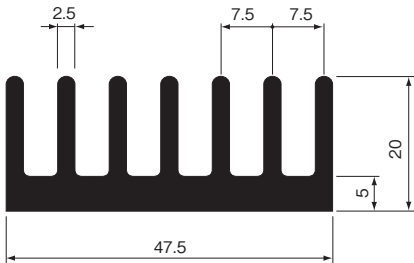

単重 1M=1.339kg

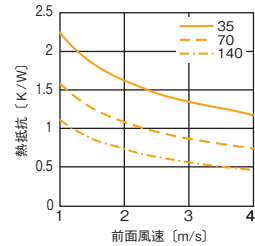
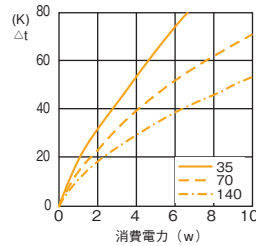

20F 70 .

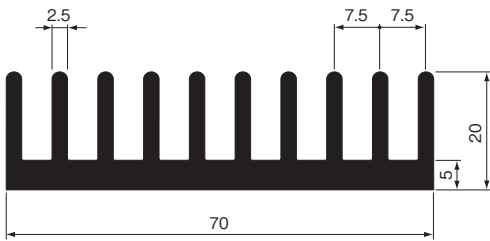

単重 1M=1.949kg

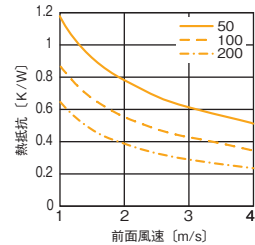
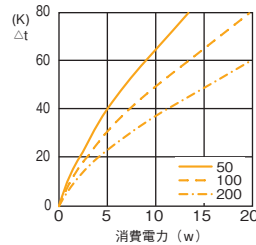

20F 85 .

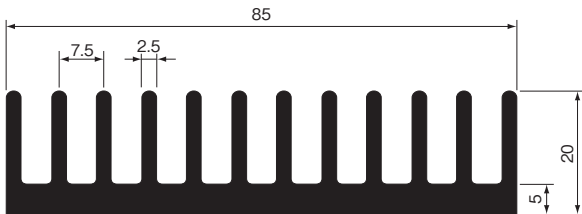

単重 1M=2.354kg

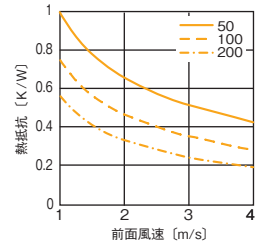
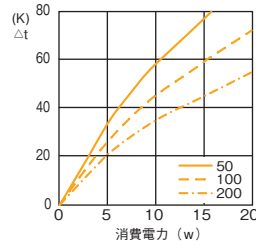

20F 153 .

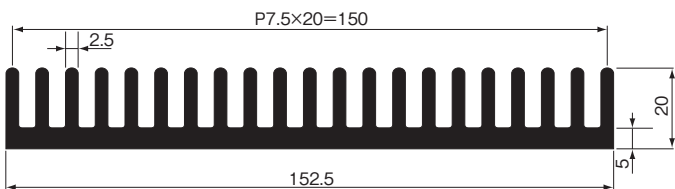

単重 1M=4.17kg

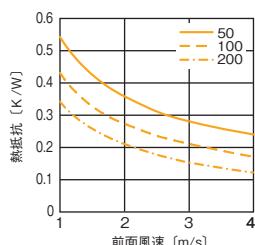
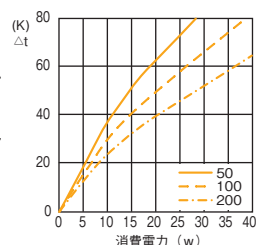

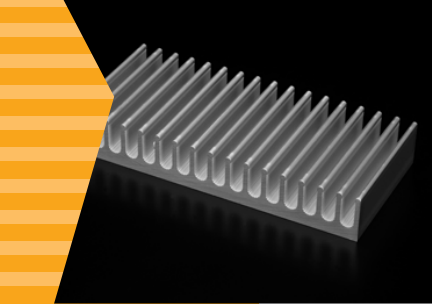

F series フラット型ハイパワー用ヒートシンク

20F 168

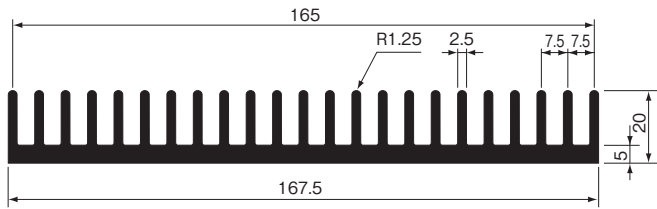

単重 1M=4.574kg

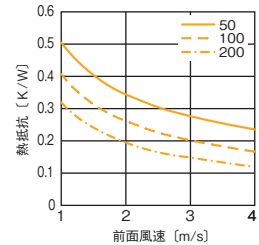
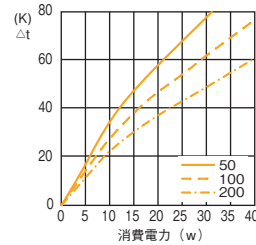

20F 193

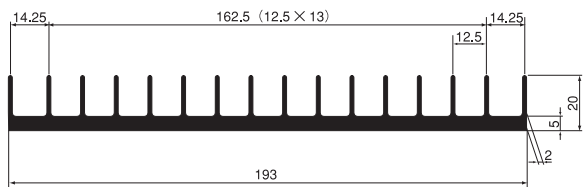

単重 1M=3.738kg

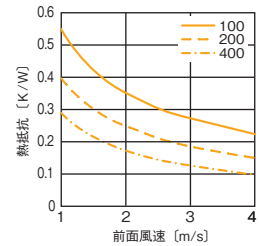
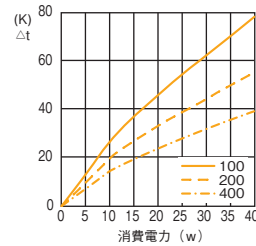

20F 220

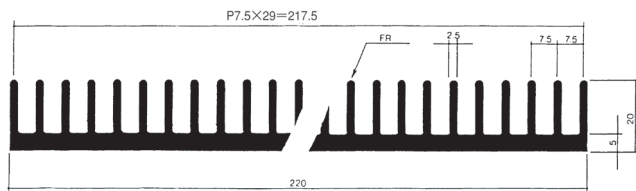

単重 1M=5.986kg

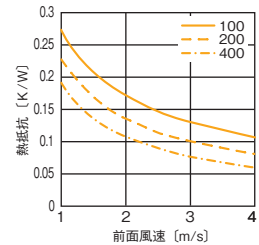
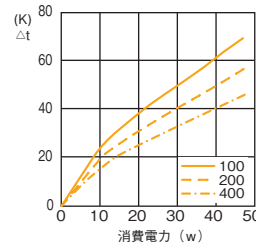

21F 26

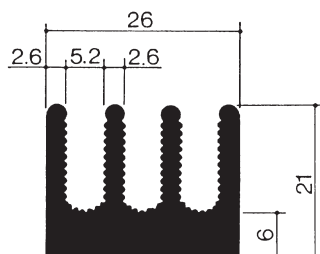

単重 1M=0.824kg

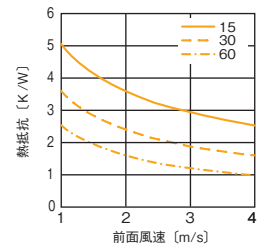
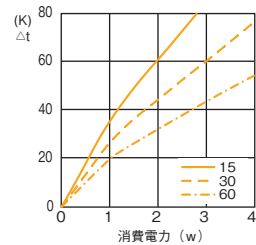

21F 42

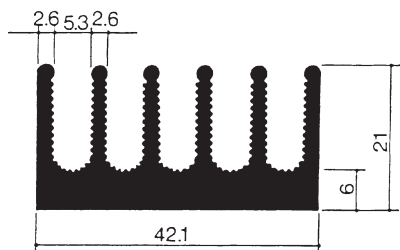

単重 1M=1.283kg

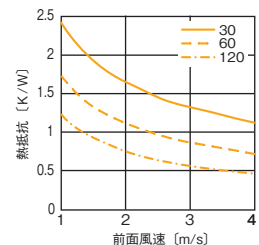
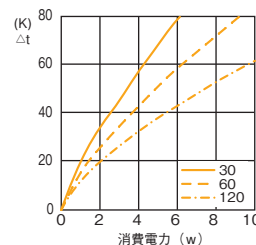

フラット型ハイパワー用ヒートシンク **F series**

21F 50

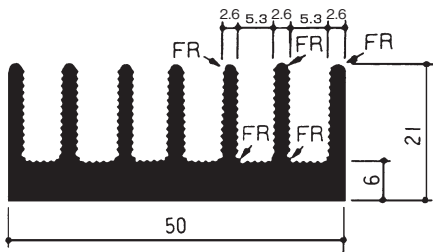

単重 1M=1.513kg

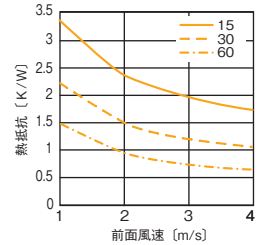
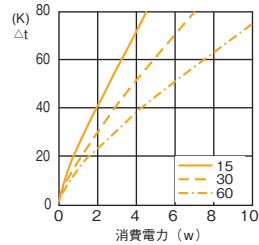

21F 74

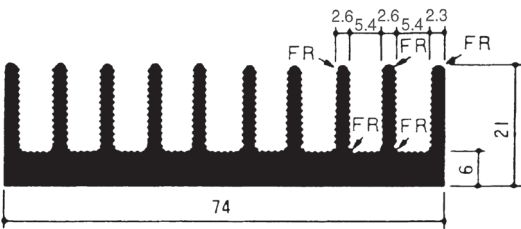

単重 1M=2.192kg

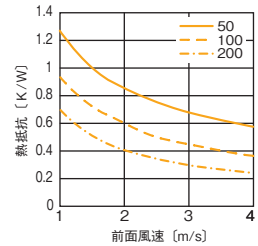
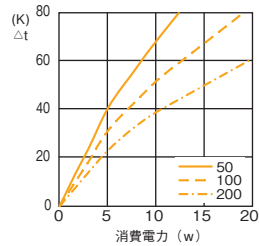

21F 98

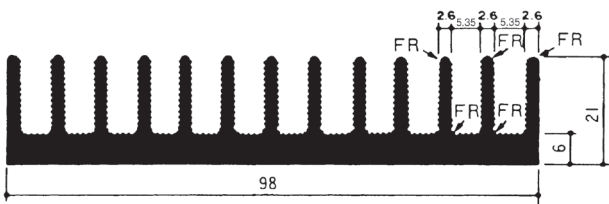

単重 1M=2.846kg

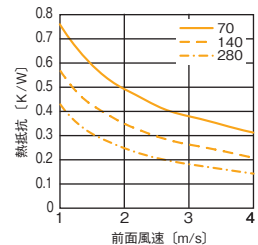
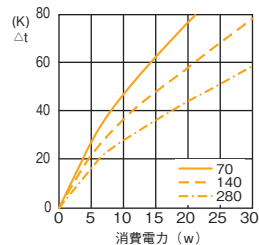

21F 130

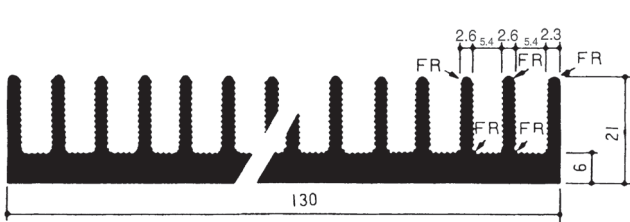

単重 1M=3.793kg

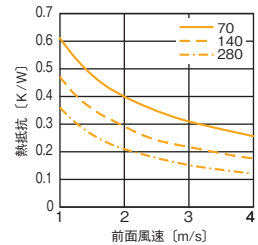
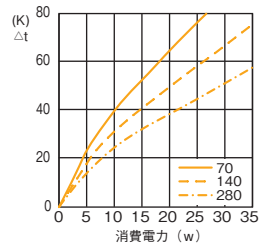

21F 154

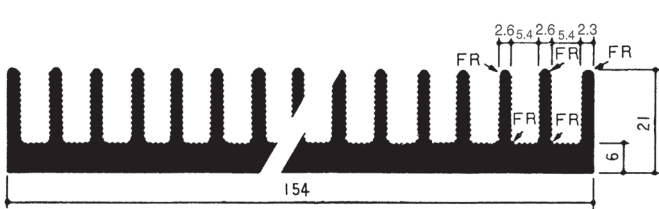

単重 1M=4.485kg

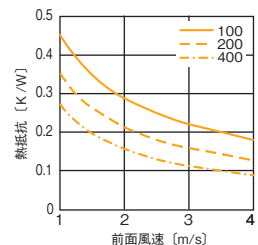
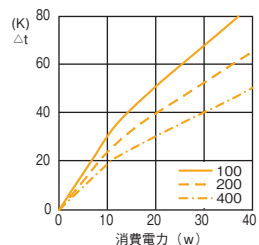

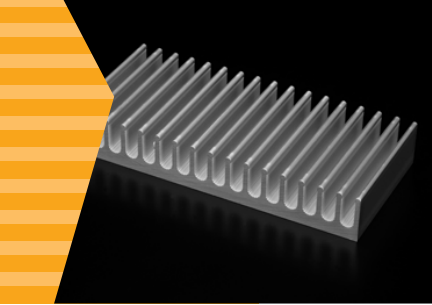

F series フラット型ハイパワー用ヒートシンク

21F 210

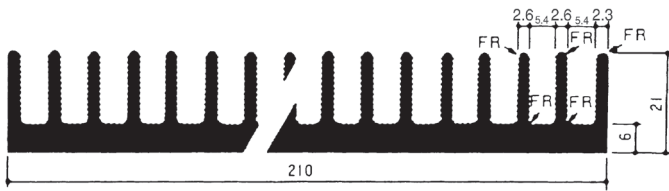

単重 1M=6.094kg

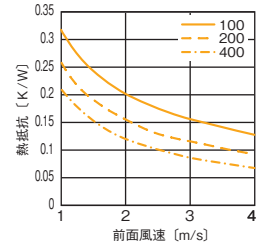
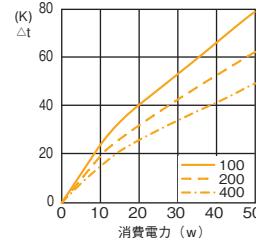

21F 230

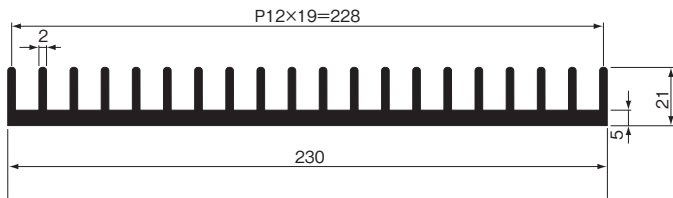

単重 1M=4.814kg

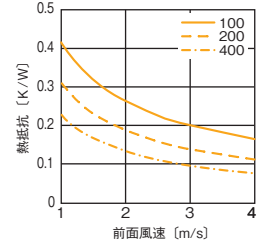
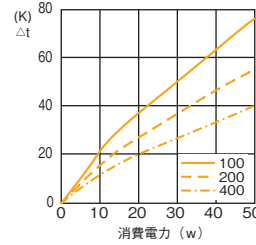

21F 298

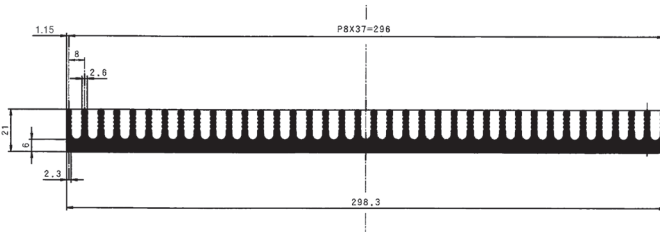

単重 1M=8.751kg

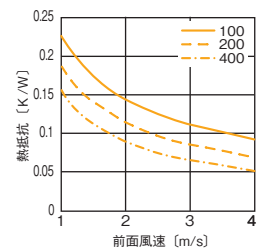
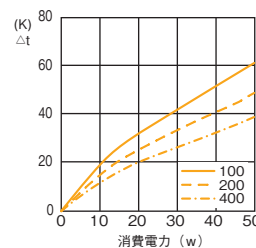

21F 372

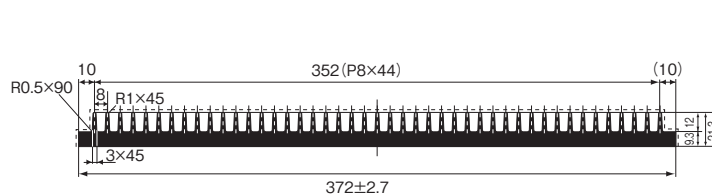

単重 1M=12.886kg

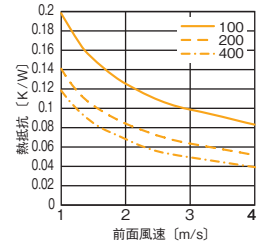
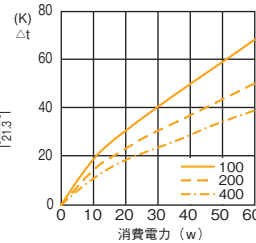

21F 413.5

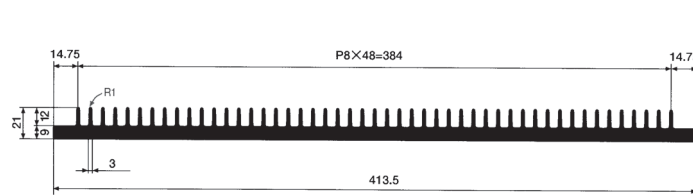

単重 1M=13.908kg

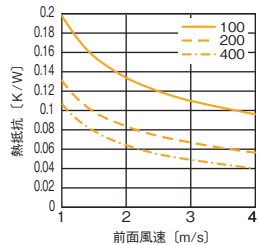
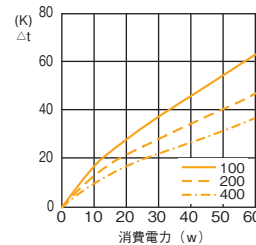

フラット型ハイパワー用ヒートシンク F series

25F 51

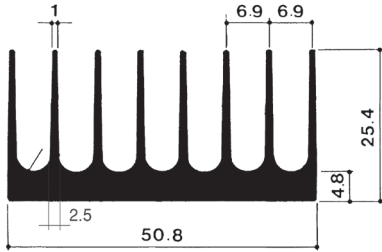

単重 1M=1.377kg

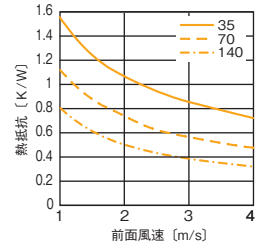
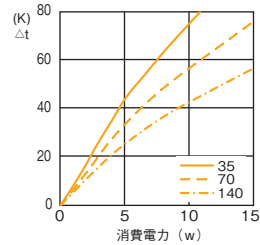

27F 100

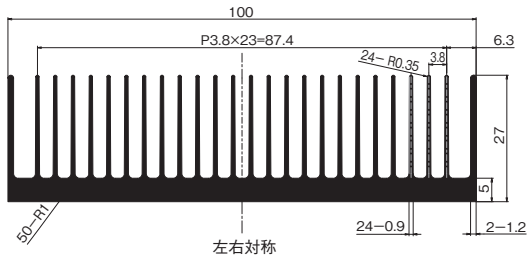

単重 1M=2.655kg

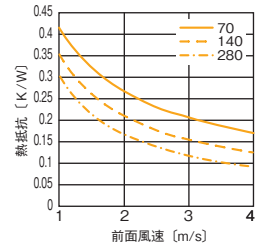
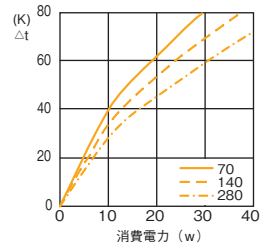

30F 34

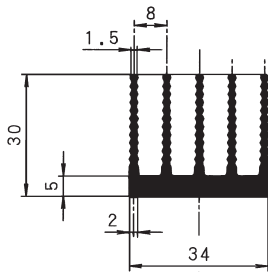

単重 1M=0.951kg

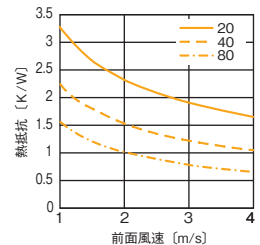
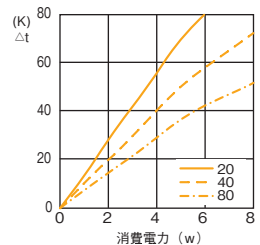

30F 50

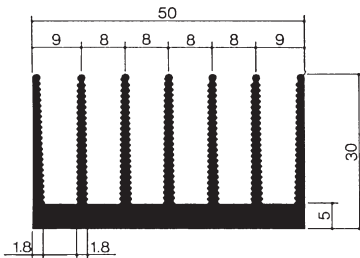

単重 1M=1.34kg

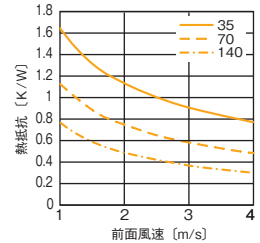
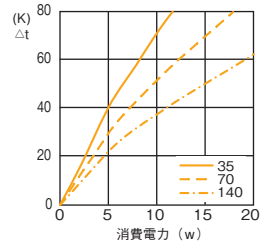

30F 58

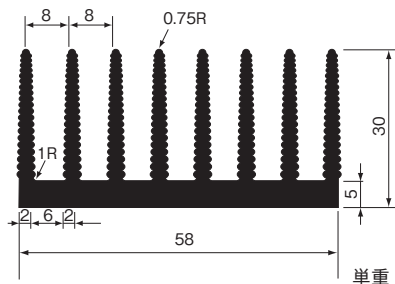

単重 1M=1.57kg

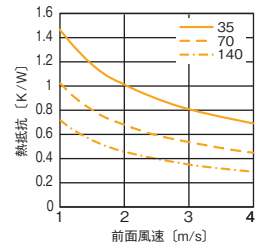
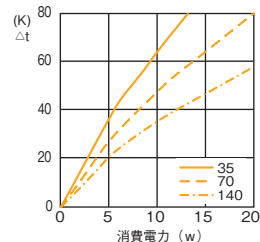

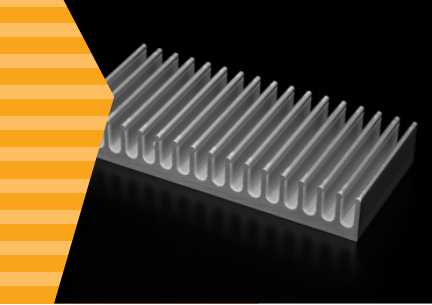

F series フラット型ハイパワー用ヒートシンク

30F 74

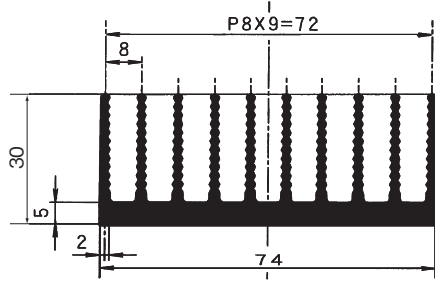

単重 1M=2.003kg

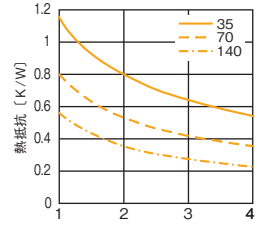
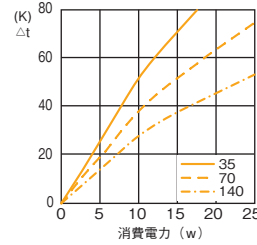

30F 98

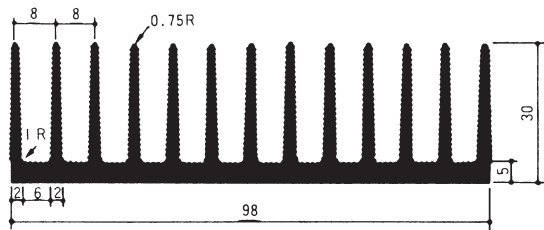

単重 1M=2.623kg

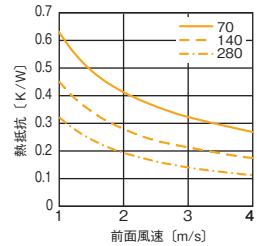
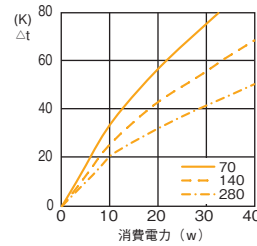

30F 138

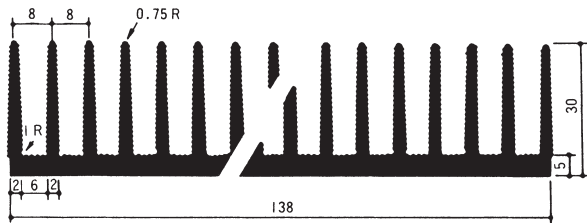

単重 1M=3.634kg

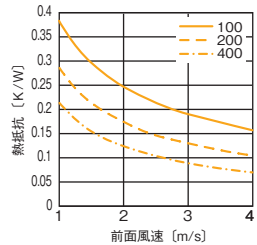
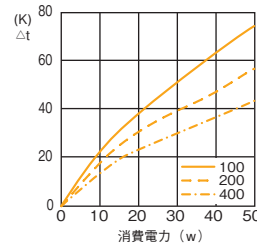

30F 165

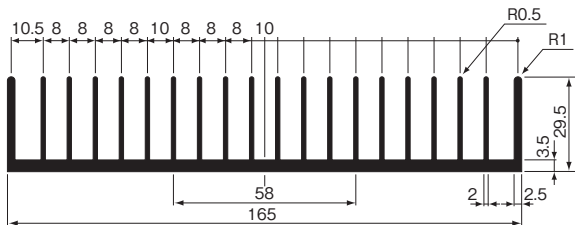

単重 1M=3.756kg

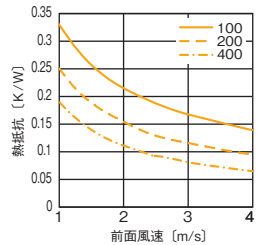
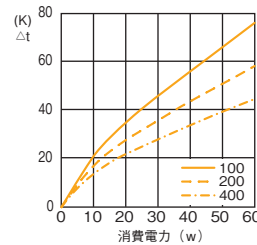

30F 202

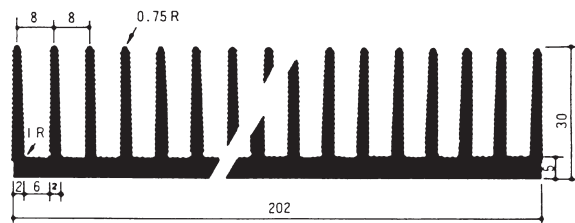

単重 1M=5.343kg

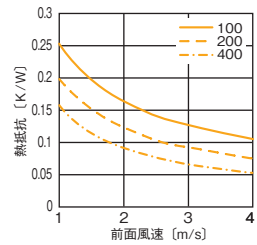
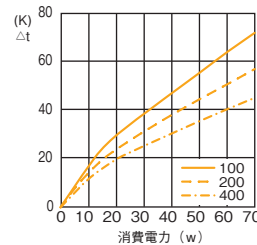

フラット型ハイパワー用ヒートシンク F series

30F 250 .

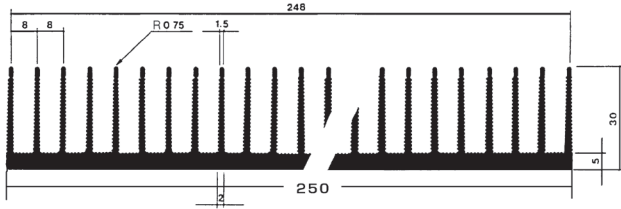

単重 1M=6.61kg

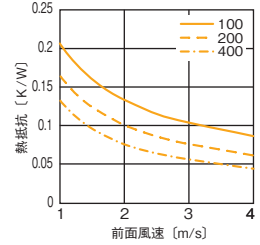
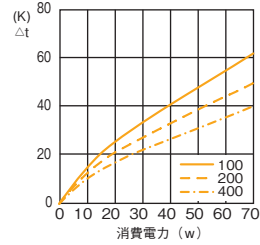

31F 50 .

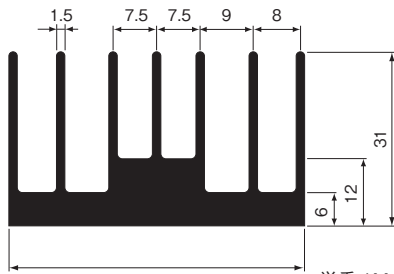

単重 1M=1.723kg

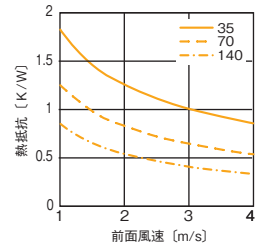
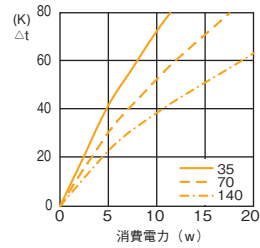

31F 156 .

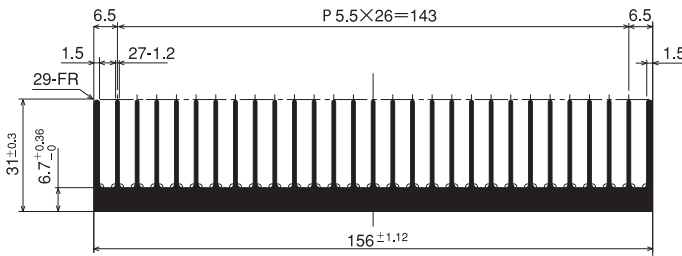

単重 1M=5.164kg

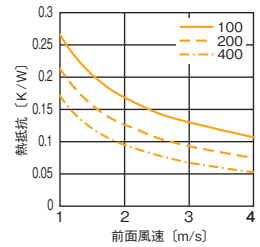
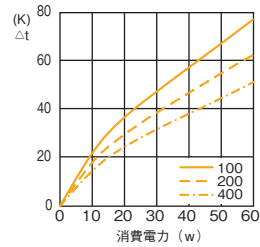

31F 339 .

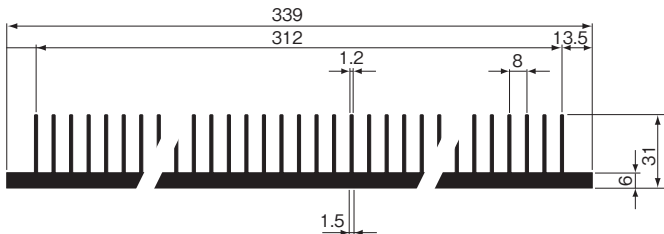

単重 1M=9.137kg

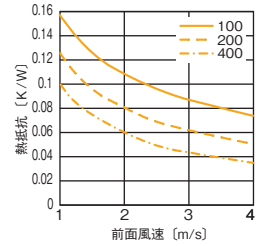
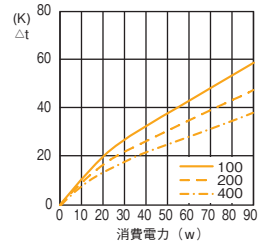

32.5F 134 .

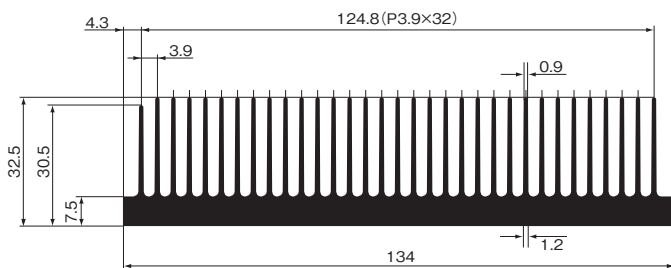

単重 1M=5.103kg

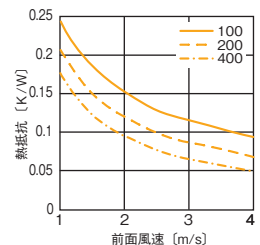
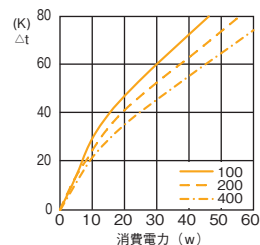

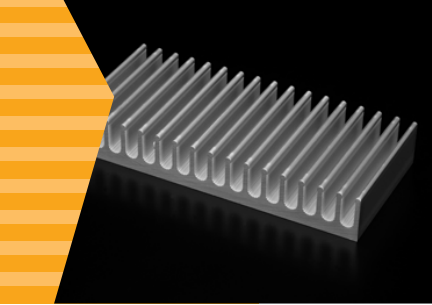

F series フラット型ハイパワー用ヒートシンク

33F 25

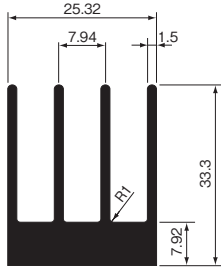

単重 1M=0.953kg

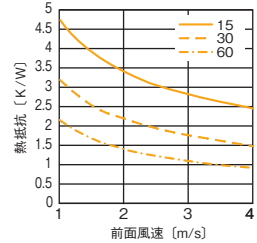
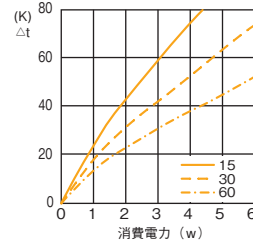

33F 41

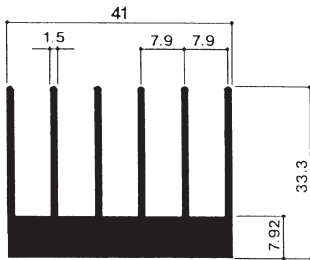

単重 1M=1.488kg

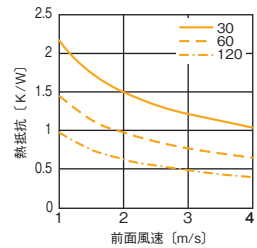
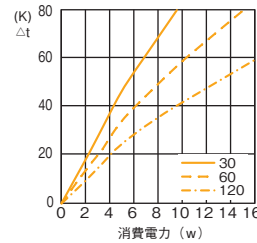

33F 49

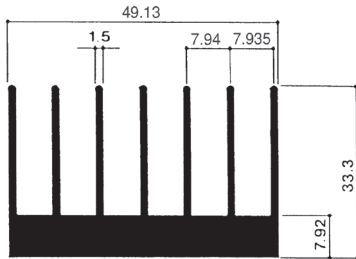

単重 1M=1.766kg

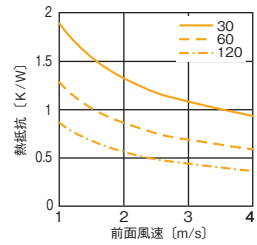
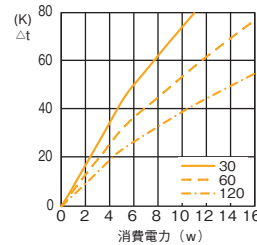

33F 73

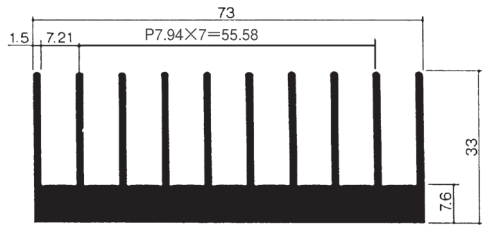

単重 1M=2.52kg

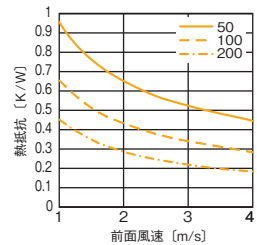
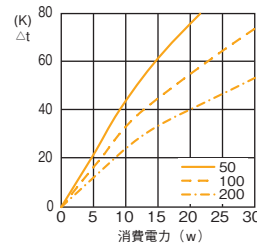

33F 136

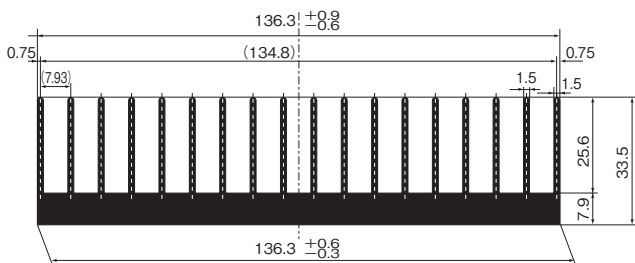

単重 1M=4.768kg

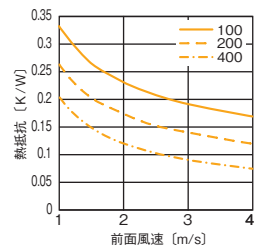
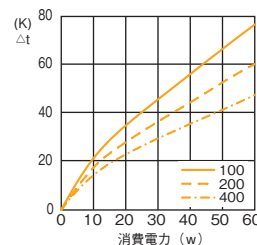

フラット型ハイパワー用ヒートシンク F series

33F 152

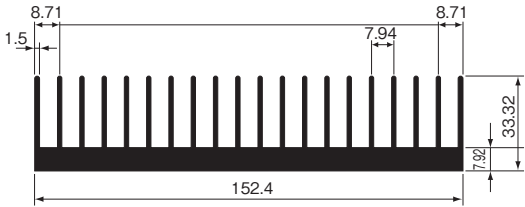

単重 1M=5.308kg

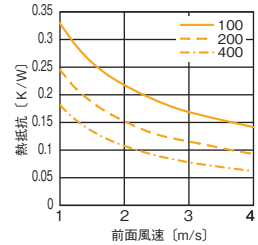
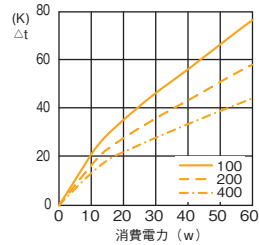

33F 176

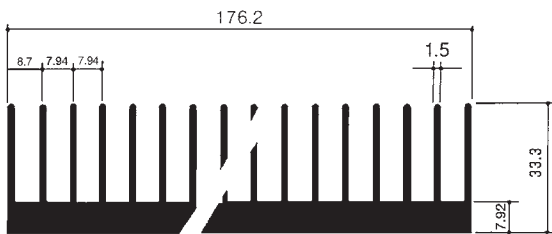

単重 1M=6.124kg

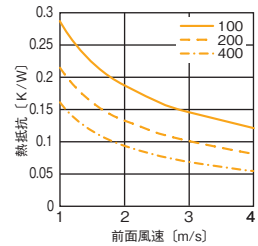
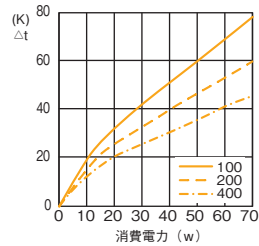

33F 192

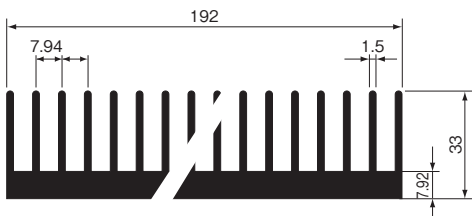

単重 1M=6.691kg

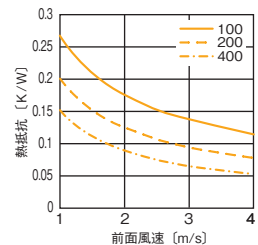
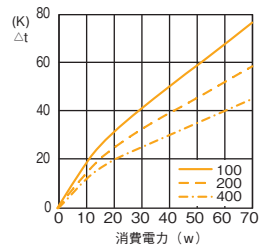

35F 240

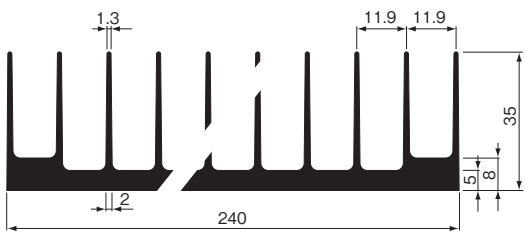

単重 1M=6.245kg

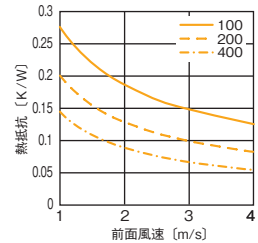
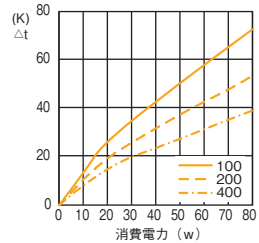

40F 100

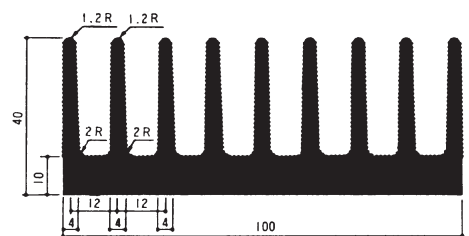

単重 1M=4.822kg

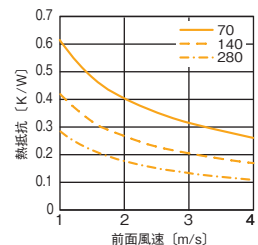
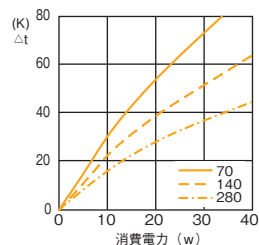

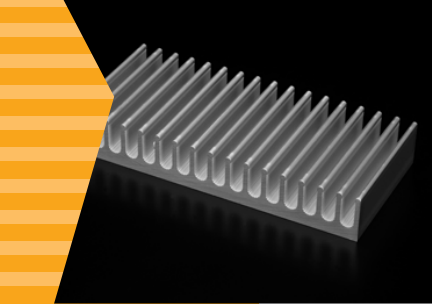

F series フラット型ハイパワー用ヒートシンク

40F 111

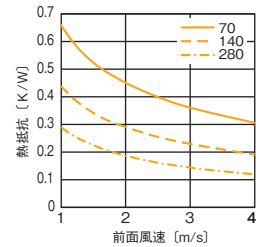
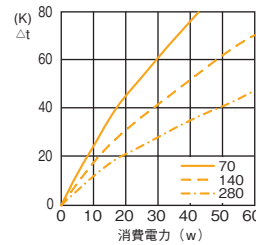
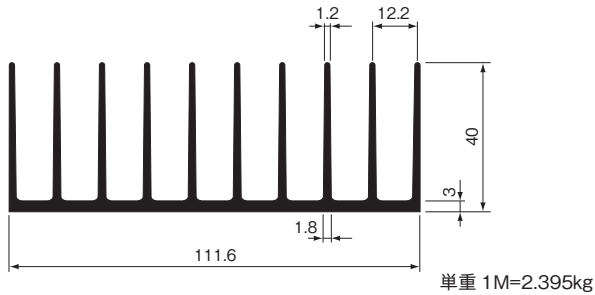

40F 136

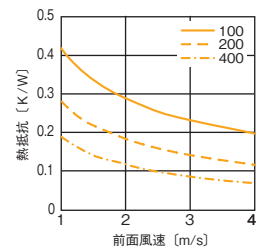
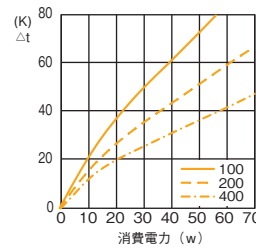
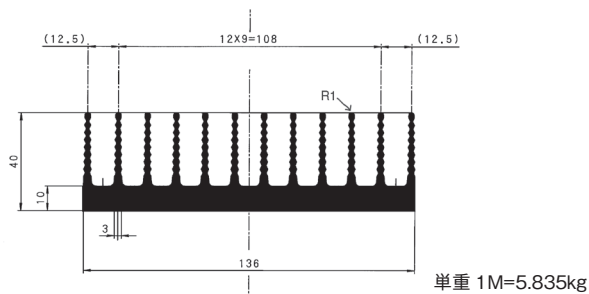

40F 140

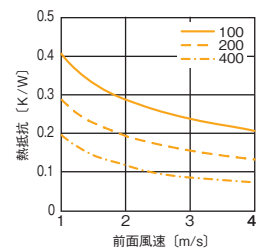
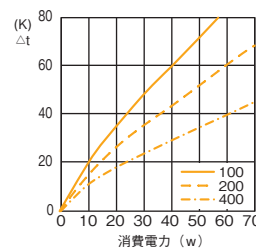
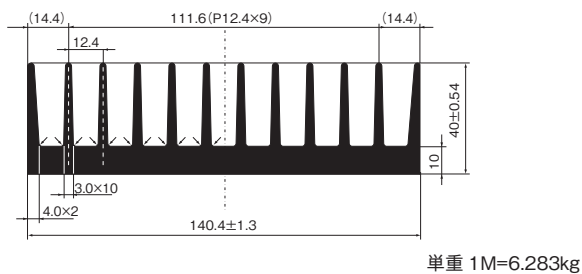

40F 160

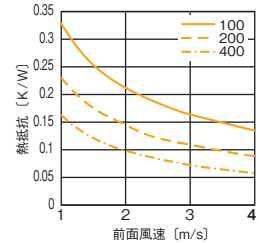
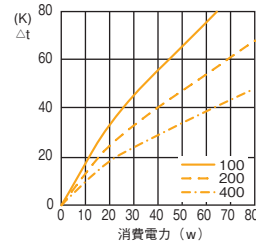
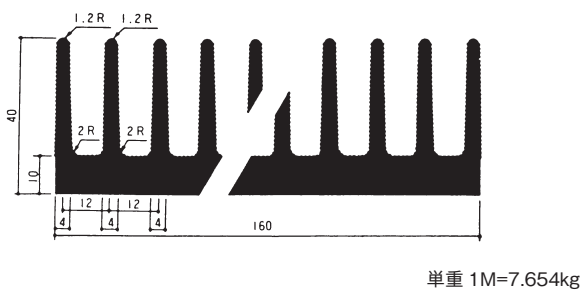

40F 220

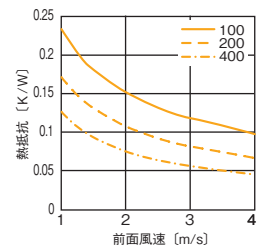
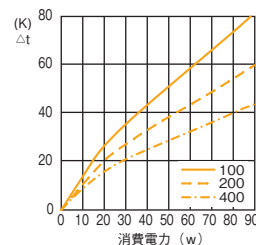
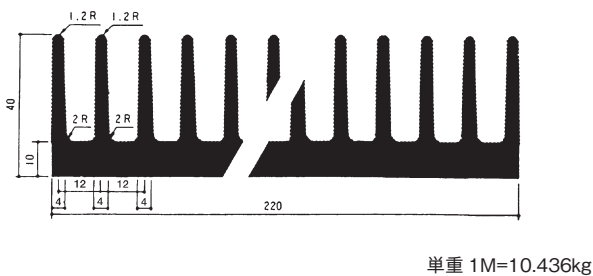

フラット型ハイパワー用ヒートシンク **F series**

40F 304

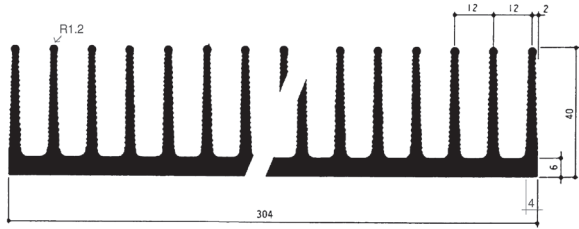

単重 1M=11.937kg

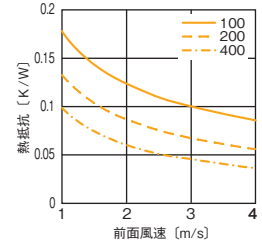
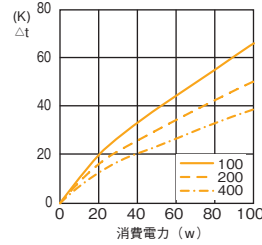

41F 219

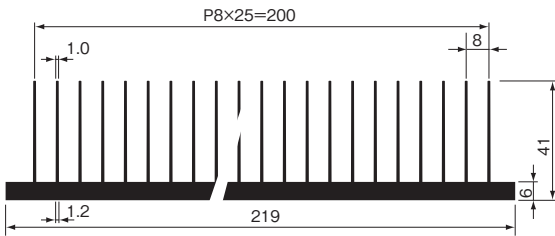

単重 1M=6.248kg

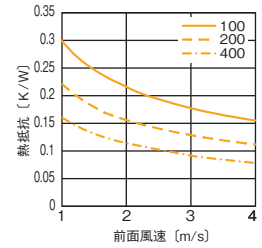
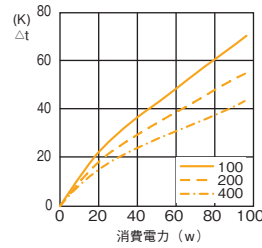

50F 114

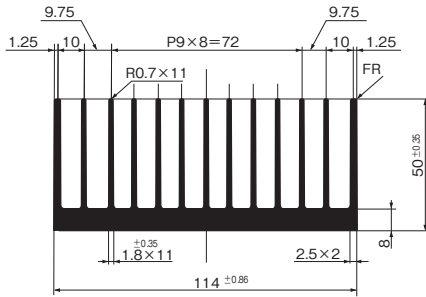

単重 1M=5.025kg

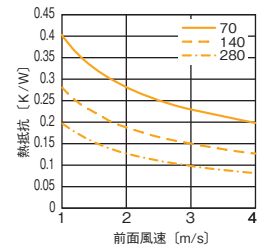
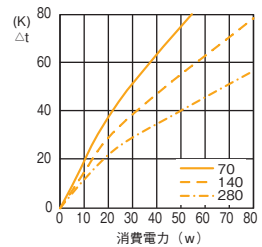

50F 146

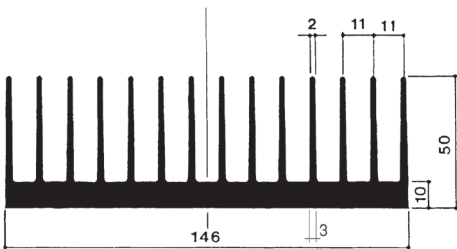

単重 1M=7.703kg

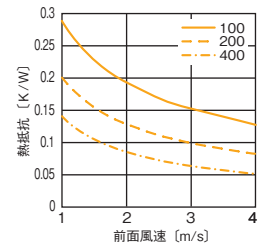
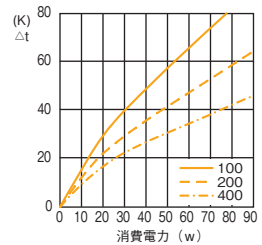

50F 199

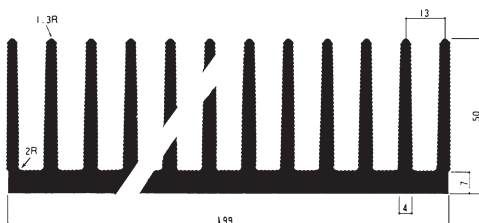

単重 1M=9.35kg

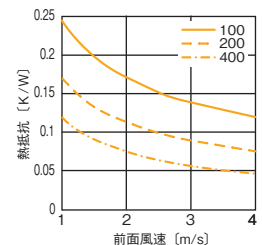
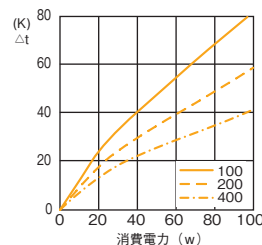

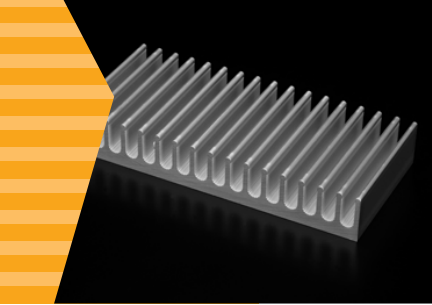

F series フラット型ハイパワー用ヒートシンク

50F 213

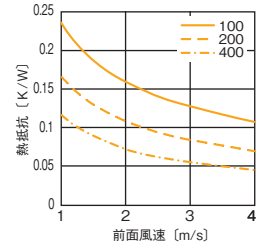
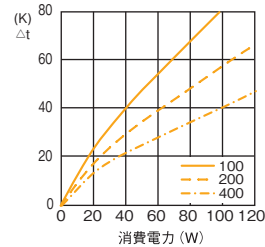
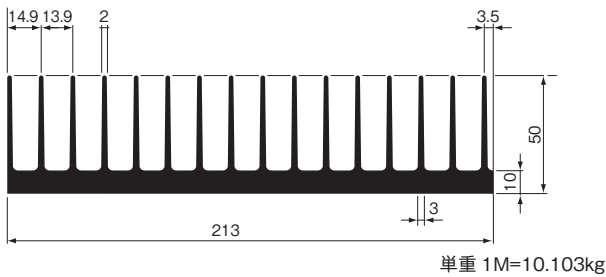

50F 251

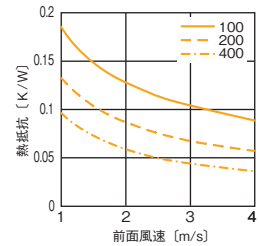
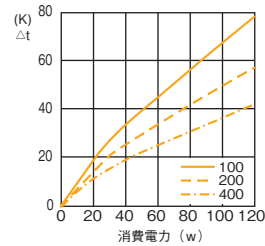
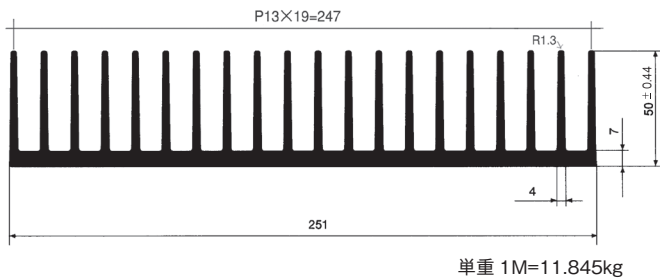

50F 300

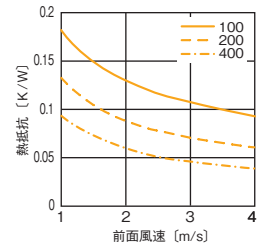
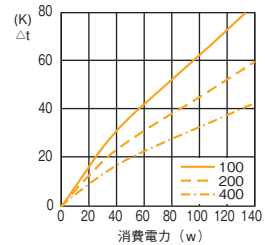
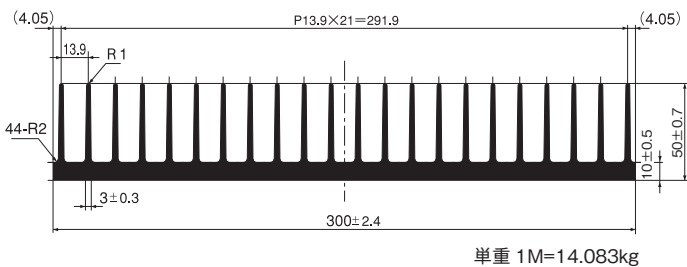

50F 350

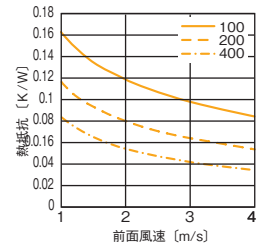
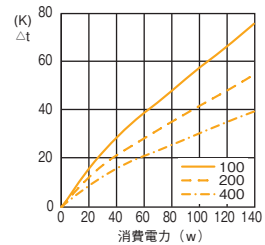
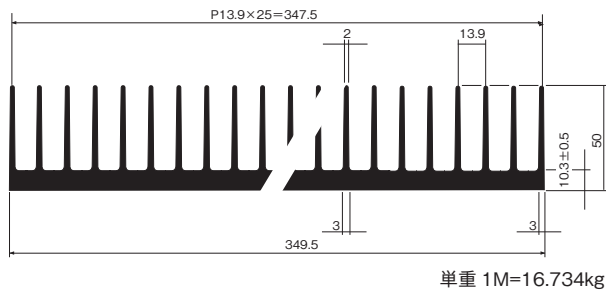

58.9F 423

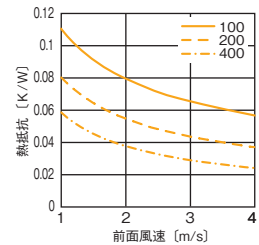
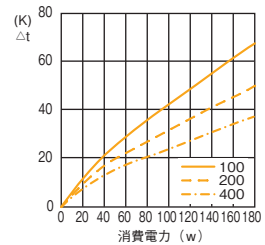
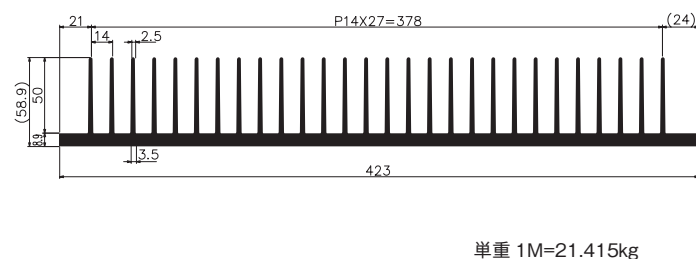

フラット型ハイパワー用ヒートシンク **F series**

60F 60 .

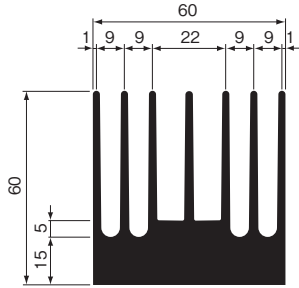

単重 1M=4.83kg

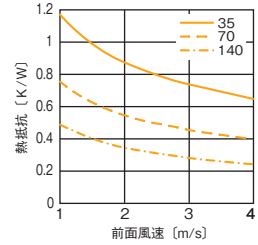
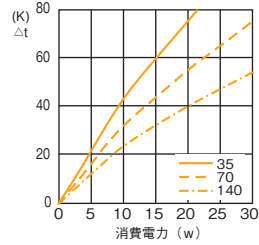

60F 110 .

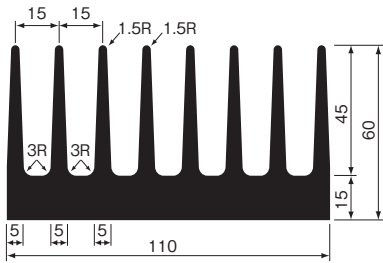

単重 1M=8.1kg

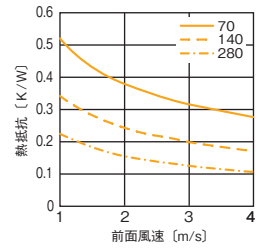
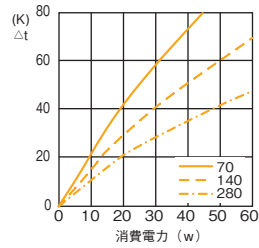

60F 230

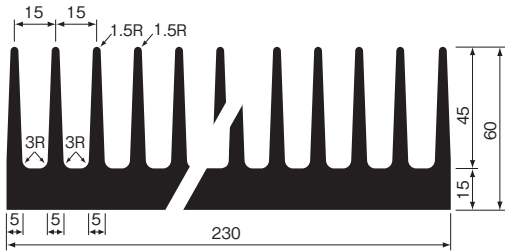

単重 1M=16.597kg

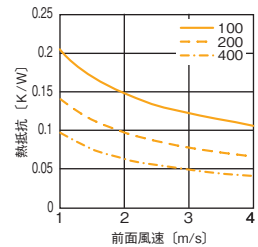
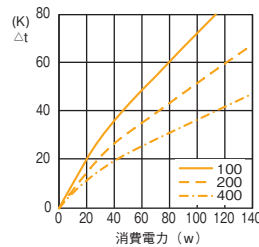

60F 262 .

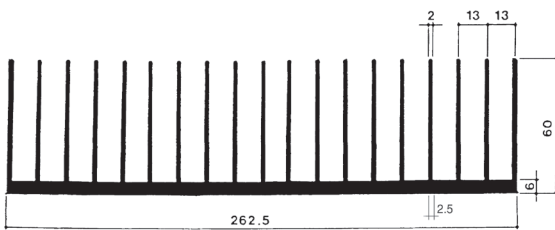

単重 1M=11.127 kg

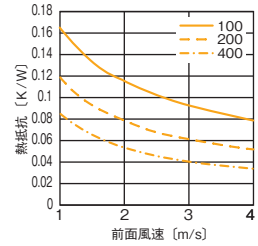
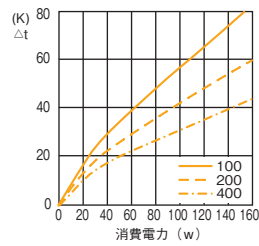

66F 230 .

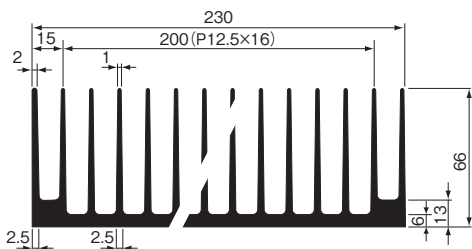

単重 1M=9.79kg

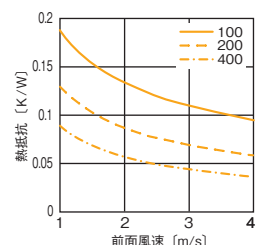
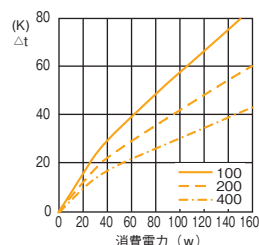

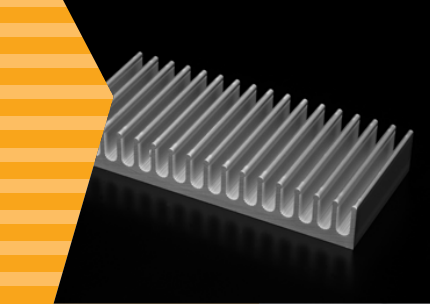

F series フラット型ハイパワー用ヒートシンク

66.5F 170

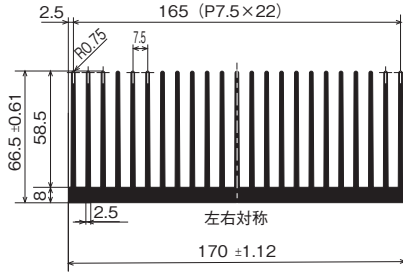

単重 1M=10.9kg

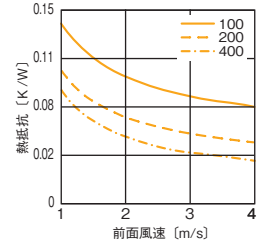
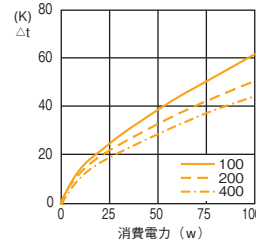

71F 206

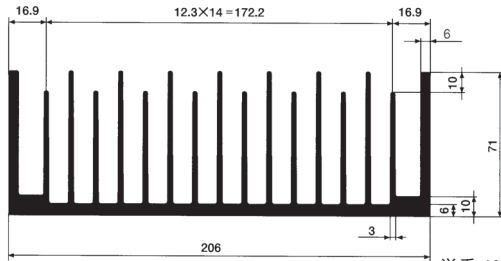

単重 1M=11.194kg

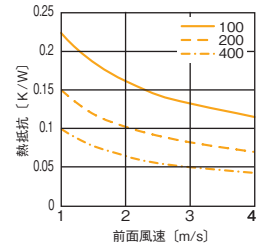
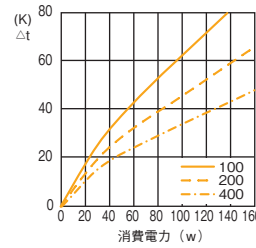

76F 286

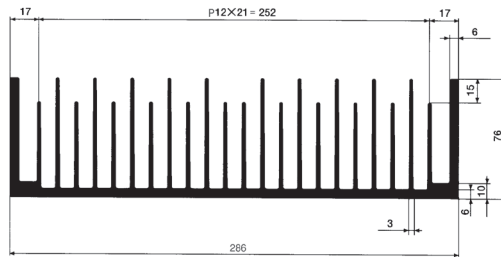

単重 1M=16.257kg

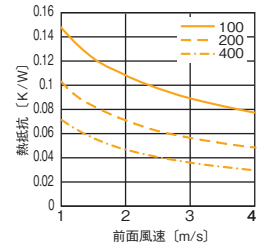
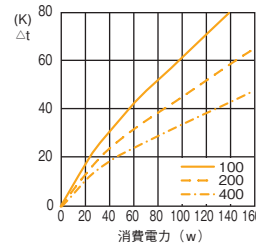

80F 150

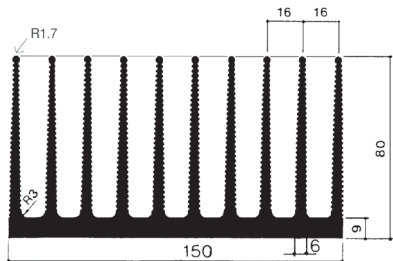

単重 1M=12.112kg

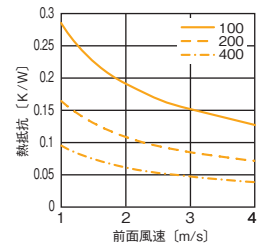
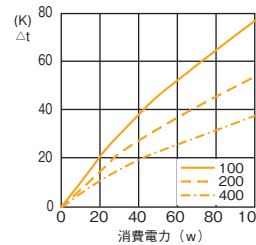

80F 246

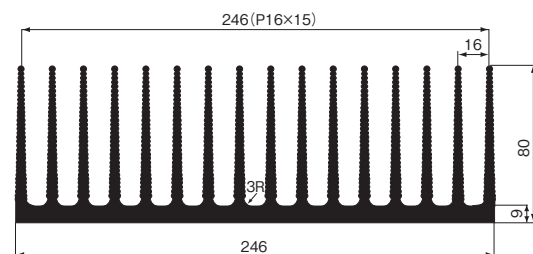

単重 1M=19.46kg

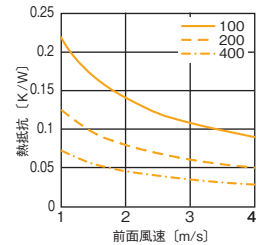
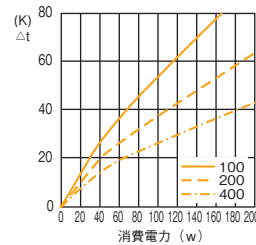

フラット型ハイパワー用ヒートシンク F series

85F 111.

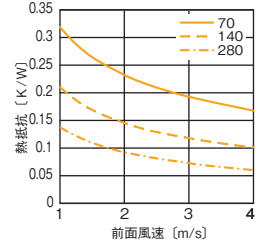
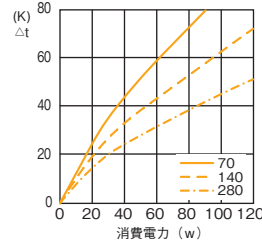
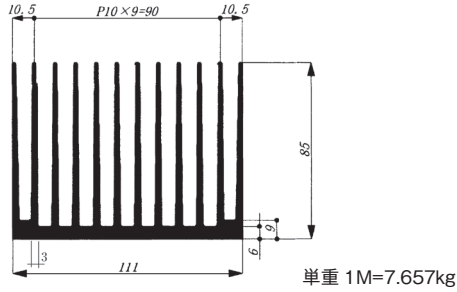

85F 125.

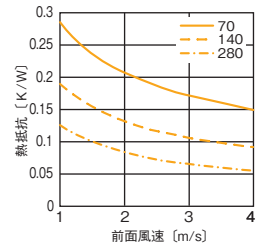
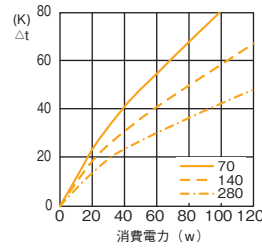
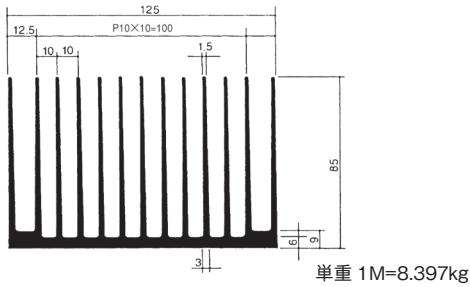

90F 125.

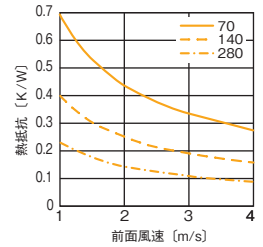
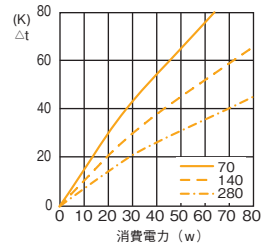
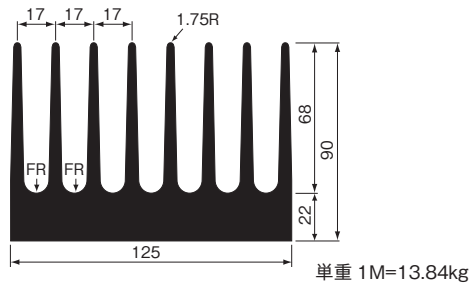

90F 147.1.

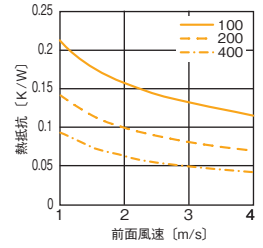
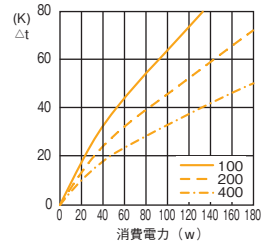
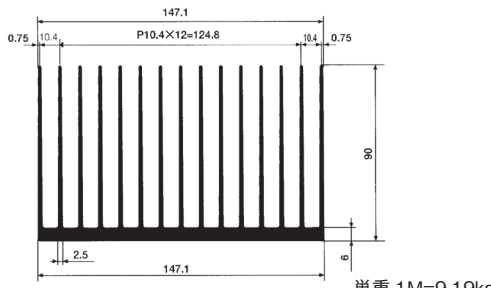

90F 188.7.

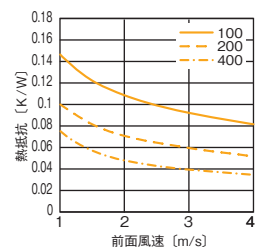
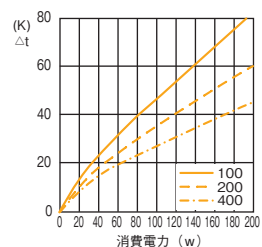
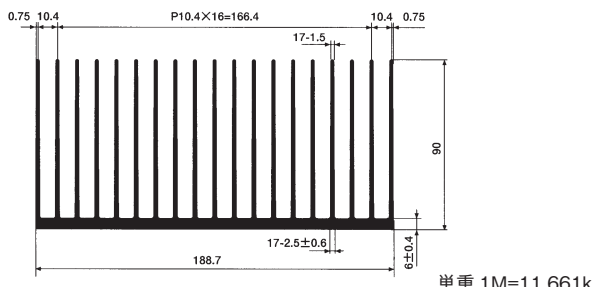

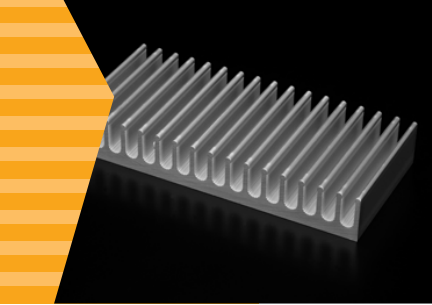

F series フラット型ハイパワー用ヒートシンク

90F 202 .

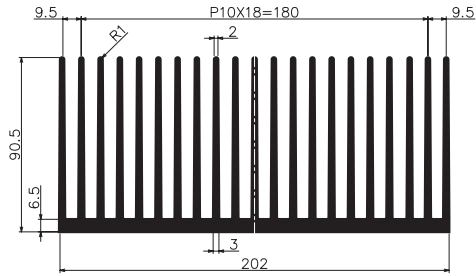

単重 1M=15.43kg

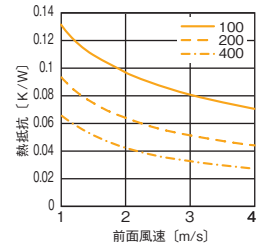
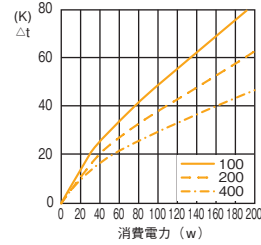

90F 294 .

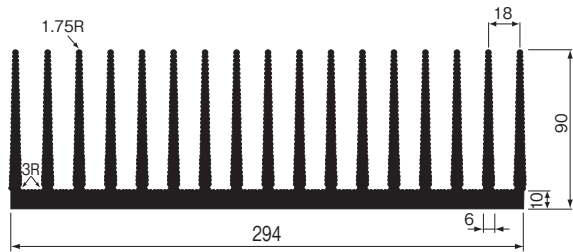

単重 1M=24.46kg

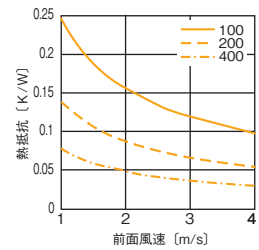
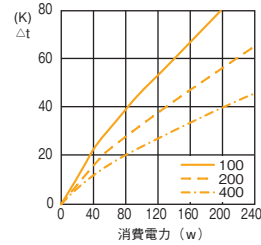

90F 337 .

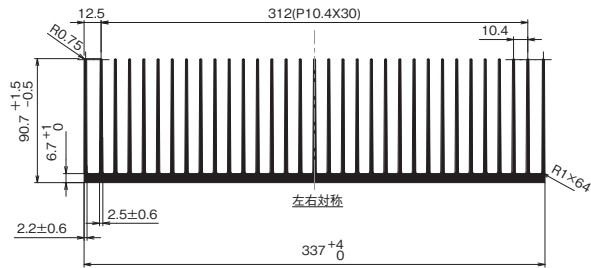

単重 1M=21.55kg

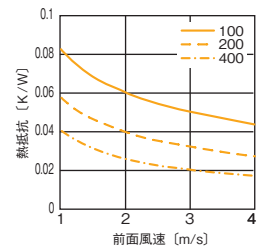
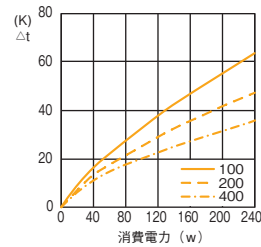

フラット型ハイパワー用ヒートシンク M series

23M 80

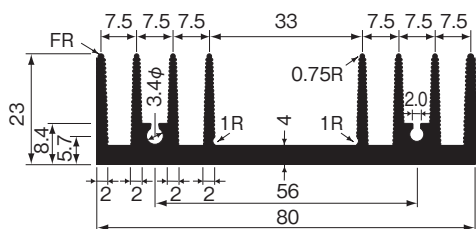

単重 1M=1.558kg

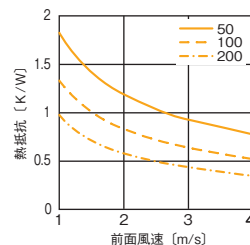
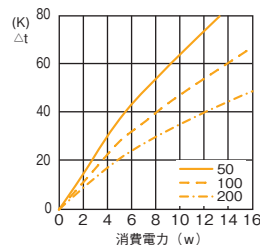

25M 103

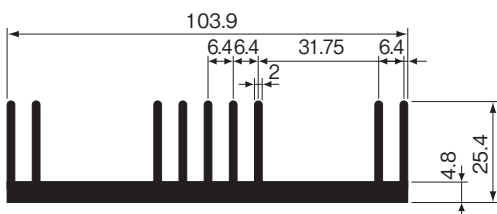

単重 1M=2.337kg

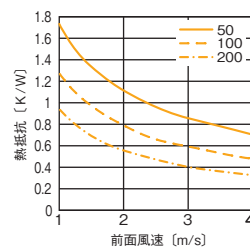
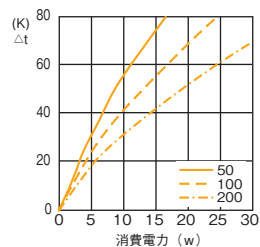

25M 150

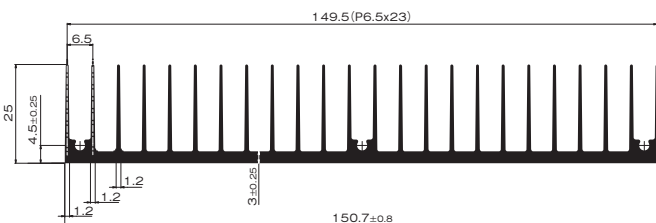

単重 1M=2.69kg ※ビスホールへのタップ加工は避けて下さい。

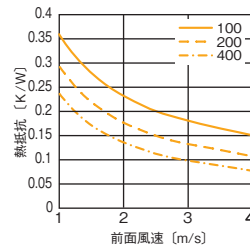
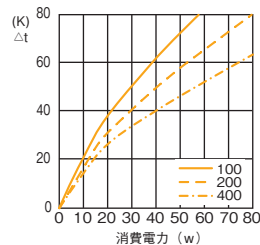

30M 40

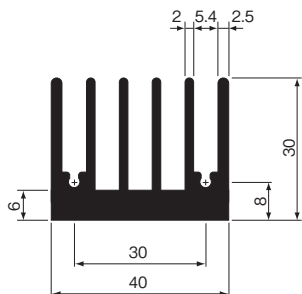

単重 1M=1.566kg

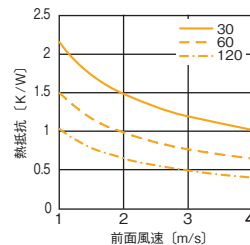
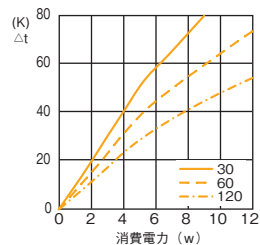

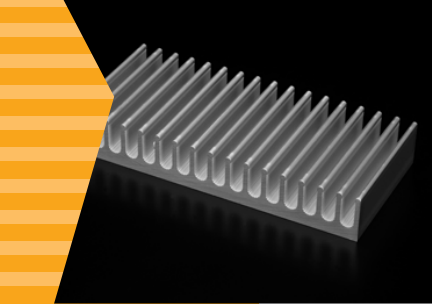

M series フラット型ハイパワー用ヒートシンク

35M 159

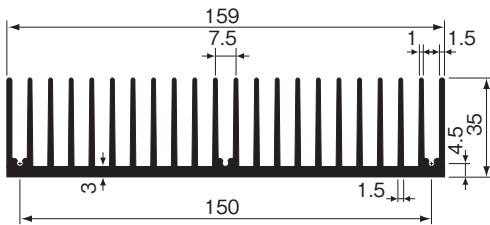

単重 1M=3.82kg

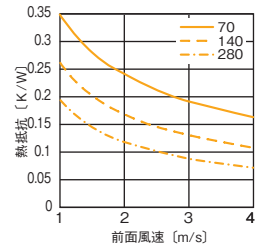
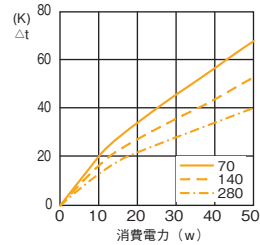

35M 234

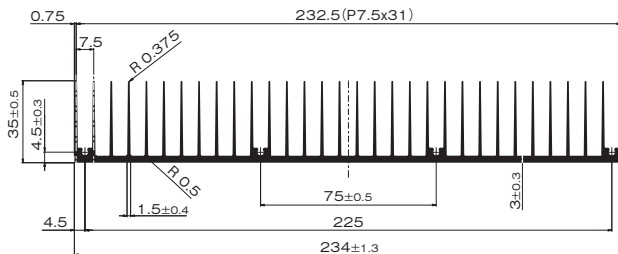

単重 1M=5.149kg ※ビスホールへのタップ加工は避けて下さい。

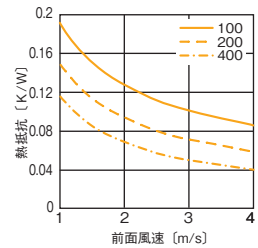
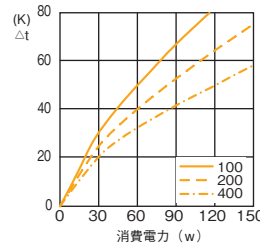

45M 239

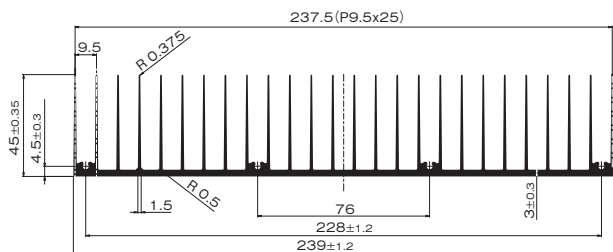

単重 1M=5.473kg ※ビスホールへのタップ加工は避けて下さい。

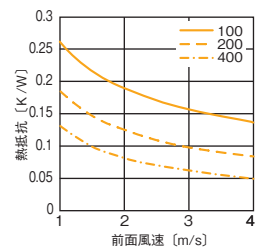
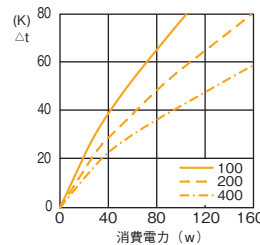

ヒートパイプ及び応用製品 **DHP series**

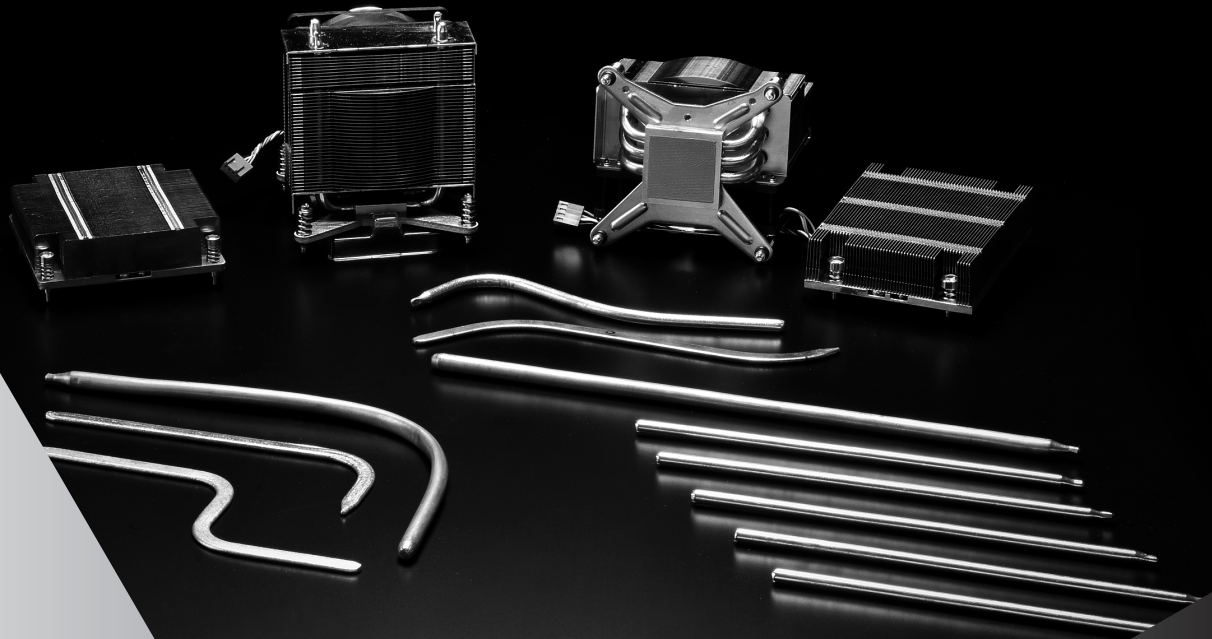

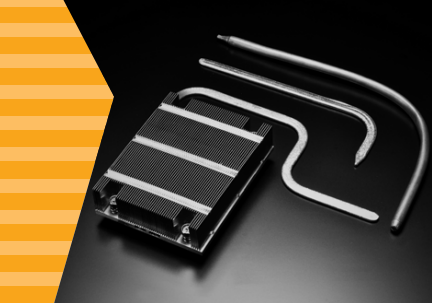

DHP series ヒートパイプ及び応用製品

ヒートパイプに関する説明

1. 外観

- 1) 管径 $\phi 6$
- 2) 長さ 125~350mm (25mm刻み)
- 3) 材質 C1020
- 4) 冷媒 水

2. 加工

- 1) 曲げR (内側) 管径の3倍以上
- 2) 扁平厚 3mmまで
※上記以外の加工に関しまして弊社営業までお尋ね下さい。

3. 性能 (参考例：焼結タイプ)

- 1) 管径と長さによる最大熱輸送量変化 [W]

管径 [mm]	長さ [mm]		
	150	200	250
6	65	50	40

※試験条件

姿勢 : 水平

受熱部長さ : 端部より15mmの地点から30mm

放熱部長さ : 端部より70mm

最大熱輸送量判断基準 : 温度差 (=受熱部温度-放熱部温度) が4℃以下であること

- 2) 角度による最大熱輸送量変化 [W]

ヒートパイプ角度	0(ボトム)	30	60	90(水平)	180(トップ)
最大熱輸送量	75	70	55	50	5

※試験条件

ヒートパイプ : 管径 $\phi 6$ 長さ200mm

受熱部長さ : 端部より15mmの地点から30mm

放熱部長さ : 端部より70mm

最大熱輸送量判断基準 : 温度差 (=受熱部温度-放熱部温度) が4℃以下であること

■平棒



2 × 10	3 × 70	5 × 35	6 × 75	9 × 50	12 × 15	15 × 50	25 × 30	35 × 40
2 × 15		5 × 40	6 × 100		12 × 20	15 × 60	25 × 35	35 × 50
2 × 20	4 × 10	5 × 50	6 × 160	10 × 15	12 × 25	15 × 75	25 × 40	35 × 60
2 × 25	4 × 12	5 × 60		10 × 20	12 × 30	15 × 100	25 × 50	35 × 85
2 × 30	4 × 15	5 × 70	8 × 15	10 × 25	12 × 40	15 × 150	25 × 60	35 × 100
2 × 40	4 × 20	5 × 100	8 × 20	10 × 30	12 × 50	15 × 200	25 × 80	
2 × 50	4 × 25		8 × 25	10 × 35	12 × 60		25 × 100	40 × 50
	4 × 30	6 × 9	8 × 30	10 × 40	12 × 75	20 × 25	25 × 150	40 × 60
3 × 10	4 × 40	6 × 10	8 × 32	10 × 45	12 × 100	20 × 30	25 × 200	40 × 75
3 × 12	4 × 50	6 × 12	8 × 35	10 × 50	12 × 120	20 × 35		40 × 100
3 × 15	4 × 60	6 × 15	8 × 40	10 × 60	12 × 150	20 × 40	30 × 40	
3 × 20	4 × 70	6 × 20	8 × 50	10 × 64		20 × 50	30 × 50	50 × 100
3 × 25		6 × 25	8 × 60	10 × 70	13 × 40	20 × 60	30 × 60	
3 × 30	5 × 10	6 × 30	8 × 75	10 × 75		20 × 70	30 × 65	76 × 100
3 × 35	5 × 15	6 × 35	8 × 100	10 × 80	15 × 20	20 × 80	30 × 75	
3 × 40	5 × 20	6 × 40		10 × 100	15 × 25	20 × 100	30 × 100	
3 × 50	5 × 25	6 × 50	9 × 30	10 × 125	15 × 30	20 × 150	30 × 150	
3 × 60	5 × 30	6 × 60	9 × 40	10 × 150	15 × 40	20 × 200	30 × 200	

■四角棒

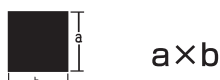

5 × 5	9 × 9	13 × 13	18 × 18	22 × 22	32 × 32	45 × 45	60 × 60	100 × 100
6 × 6		14 × 14	19 × 19	25 × 25	35 × 35		70 × 70	
7 × 7	10 × 10	15 × 15				50 × 50	80 × 80	
8 × 8	12 × 12	16 × 16	20 × 20	30 × 30	40 × 40	55 × 55	90 × 90	

■等辺アングル

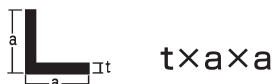

1.2 × 10 × 10	1.5 × 20 × 20	2 × 10 × 10	2 × 50 × 50	3 × 30 × 30	4 × 25 × 25	5 × 30 × 30	6 × 40 × 40	9 × 75 × 75
1.2 × 12 × 12	1.5 × 25 × 25	2 × 15 × 15		3 × 35 × 35	4 × 30 × 30	5 × 40 × 40	6 × 50 × 50	
	1.5 × 30 × 30	2 × 20 × 20	3 × 15 × 15	3 × 40 × 40	4 × 35 × 35	5 × 50 × 50	6 × 60 × 60	10 × 100 × 100
1.5 × 10 × 10	1.5 × 50 × 50	2 × 25 × 25	3 × 20 × 20	3 × 50 × 50	4 × 40 × 40	5 × 60 × 60	6 × 65 × 65	
1.5 × 15 × 15		2 × 30 × 30	3 × 25 × 25		4 × 50 × 50			

■不等辺アングル



1.5 × 10 × 15	1.5 × 10 × 30	1.5 × 15 × 20	2 × 15 × 20	2 × 20 × 30	2.5 × 13 × 35	3 × 20 × 40	4 × 35 × 50	5 × 50 × 75
1.5 × 10 × 20	1.5 × 10 × 40	1.5 × 15 × 25	2 × 15 × 25	2 × 20 × 40		3 × 25 × 50		
1.5 × 10 × 25			2 × 15 × 30	2 × 20 × 50	3 × 20 × 30		5 × 40 × 60	

■チャンネル



1.5 × 10 × 10	2 × 18 × 10	2 × 25 × 25	2.4 × 30 × 30	3 × 30 × 25	3 × 60 × 30	4 × 80 × 40	5 × 100 × 50	
	2 × 20 × 20	2 × 30 × 15	2.4 × 35 × 20	3 × 40 × 20				
2 × 15 × 15	2 × 22 × 12	2 × 40 × 20		3 × 50 × 25	3.2 × 75 × 40	5 × 75 × 50		

■角パイプ



別途お問い合わせ下さい。